



**IFB NO. 24-012**

**INVITATION FOR BID**

**FOR**

**BUS STOP IMPROVEMENTS CONSTRUCTION GROUP K**

**July 15, 2024**

**Table of Contents**

**SECTION 1. INTRODUCTION..... 3**

**1.1 STATEMENT OF INTENT ..... 3**

**1.2 BACKGROUND..... 3**

**1.3 PRE-PROPOSAL MEETING ..... 3**

**1.4 DISADVANTAGED BUSINESS ENTERPRISES..... 3**

**1.5 PERMITS ..... 4**

**1.6 USE OF BRAND OR TRADE NAMES ..... 4**

**1.7 GOTRIANGLE PROJECT CONTACTS..... 4**

**SECTION 2. SCOPE OF WORK..... 5**

**2.1 SCOPE AND SERVICES TO BE PERFORMED ..... 5**

**2.2 PERIOD OF PERFORMANCE..... 5**

**2.3 BID DOCUMENT ATTACHMENTS..... 5**

**SECTION 3. BID REQUIREMENTS ..... 6**

**3.1 INFORMATION REQUIRED FROM THE CONTRACTOR ..... 6**

**3.2 GENERAL BID REQUIREMENTS ..... 7**

**3.3 CHANGES TO IFB DOCUMENT(ADDENDA) ..... 8**

**3.4 QUESTIONS ..... 8**

**3.5 BID OPENING ..... 9**

**3.6 EXAMINATION OF BIDS AND DETERMINATION OF RESPONSIVENESS ..... 9**

**SECTION 4. AWARD CRITERIA..... 9**

**4.1 SELECTION ..... 9**

**4.2 SELECTION PROCESS PROTEST PROCEDURES ..... 9**

**4.3 ACCEPTANCE OR REJECTION OF BIDS..... 10**

**4.4 SCHEDULE OF EVENTS ..... 11**

**SECTION 5. GENERAL BID CONDITIONS..... 12**

**5.1 NOTICE OF FORMAL SOLICITATION ..... 12**

**5.2 METHOD OF RESPONSE ..... 12**

**5.3 ACCEPTANCE OF TERMS AND CONDITIONS ..... 12**

**5.4 FALSE, INCOMPLETE OR UNRESPONSIVE STATEMENTS ..... 12**

**5.5 CLEAR AND CONCISE SUBMISSION ..... 12**

**5.6 PRIME CONTRACTOR RESPONSIBILITIES ..... 12**

**SECTION 6. ATTACHMENTS..... 13**

# INVITATION FOR BID

## FOR

### Bus Stop Improvements Construction Group K

#### **SECTION 1. INTRODUCTION**

##### **1.1 STATEMENT OF INTENT**

Research Triangle Regional Transportation Authority D/B/A GoTriangle ("GoTriangle") invites qualified and experienced firms with recent and relevant experience to submit Bids for consideration to contract with GoTriangle to provide **Bus Stop Improvements Construction Group K** as set forth in this solicitation. Firms may express interest and request consideration by submitting bid material to GoTriangle as set forth in this Invitation for Bid.

To obtain a copy of the Invitation for Bid (IFB) document, Contractors shall download the document from the GoTriangle's website at <https://gotriangle.org>.

Bids will be received until 10:00 a.m. on **Thursday August 15, 2024 (EDST)** on at GoTriangle's Administrative Office located at 4600 Emperor Blvd., Suite 100, Durham, North Carolina, 27703. Questions regarding the Bids shall be directed to William Bryant, Interim Procurement Manager at [wbryant@gotriangle.org](mailto:wbryant@gotriangle.org). GoTriangle reserves the right to reject any or all Bids.

Bids are due by 10:00 am. Bids will be opened virtually via MS Teams at 11:00 am.

##### **1.2 BACKGROUND**

Bidder hereby proposes to furnish all materials, tools, machinery, equipment, apparatus, labor, and all means necessary to perform all tasks detailed in the Scope of Work.

##### **1.3 PRE-PROPOSAL MEETING**

A Non-mandatory Pre-Bid Conference will be held, via **Microsoft Teams Meeting at 9:00 a.m. on Tuesday July 23, 2024**. The meeting information is listed below. The purpose of this meeting is to offer an opportunity for prospective bidders to familiarize themselves with the site and ask questions pertaining to the project and Contract Documents.

#### **Microsoft Teams meeting**

**Join on your computer, mobile app or room device**

Meeting ID: 248 836 813 304

Passcode: ZtMVAs

#### **Dial in by phone**

[+1 252-210-4099](tel:+12522104099), [134955703](tel:+134955703)# United States, Rocky Mount

[Find a local number](#)

#### **DISADVANTAGED BUSINESS ENTERPRISES**

Pursuant to 49 C.F.R. Part 26, GoTriangle has established a Disadvantaged Business Enterprise (DBE) Program that states “GoTriangle shall not discriminate in any manner on the basis of race, color, sex or national origin, and shall take all reasonable steps to ensure that certified Disadvantaged Business Enterprises have the maximum opportunity to participate in the performance of contracts.

In conformity with North Carolina State law, it is the policy of GoTriangle to encourage and promote the use of minority contractors, physically handicapped contractors, and women contractors in the purchasing of goods and the provision of services. Proposers are encouraged to utilize minority, handicapped and women-owned businesses to the extent possible when assembling its team.

Jamila Ormond, GoTriangle Director of Equal Opportunity Employment/Disadvantaged Business Enterprises may be reached at 919-485-7518 or [jormond@GoTriangle.org](mailto:jormond@GoTriangle.org) with questions about GoTriangle’s DBE Program. **This project has a 15.48% DBE Goal.**

#### **1.4 PERMITS**

The Contractor is responsible to obtain, at their expense, any permits, certifications and/or licenses to complete the construction project. Copies of all inspections and permits shall be given to GoTriangle for record keeping. All work must comply with all safety, electrical, and building codes of the State of North Carolina and local ordinances.

#### **1.5 USE OF BRAND OR TRADE NAMES**

The use of brand names, trade names, types, styles, model numbers and serial numbers are intended to be descriptive only and not intended to restrict competition. Specific brand names will be used as a comparative measure of the safety, quality and performance against all Bid submissions. However, other brand names, types, styles, model numbers have to be “equal” and meet the minimum requirements of the OEM.

#### **1.6 GOTRIANGLE PROJECT CONTACTS**

Unless otherwise notified:

1. **Pre-Award Contact:** Prior to contract award all questions, comments, correspondence and Bid packages shall be transmitted to the attention of the following individual, serving as the Owner’s Representative during Pre-Award:

**William Bryant, Procurement Administrator**

Office: 919-485-7429

[wbryant@gotriangle.org](mailto:wbryant@gotriangle.org)

2. **Post-Award Contact:** After the contract is awarded, the contractor and subcontractors shall transmit all project related questions, correspondence and other communications to the attention of the following individual, serving as the Owner’s Representative during Post-Award:

**Senior Engineer Design, GoTriangle**

**Bong Vang**

Office: 919-485-7557

[bvang@gotriangle.org](mailto:bvang@gotriangle.org)

## **SECTION 2. SCOPE OF WORK**

### **2.1 SCOPE AND SERVICES TO BE PERFORMED**

Attached are plans and specification to provide all labor, materials, equipment and supplies to complete tasks related to the bus stop amenity improvements located at various locations in Town of Chapel Hill, Raleigh, and Durham , North Carolina.

### **2.2 PERIOD OF PERFORMANCE**

Contractor has 60 (sixty) calendar days from the date of Notice to Proceed to the final closeout and Owner acceptance of the project for the base bid.

### **2.3 BID DOCUMENT ATTACHMENTS**

- 1 Exhibit A Construction Group K Drawings.pdf
- 2 Exhibit B Construction Group K Technical Specifications

**END OF SPECIFICATIONS**

## **SECTION 3. BID REQUIREMENTS**

### **3.1 INFORMATION REQUIRED FROM THE CONTRACTOR**

#### **Contractor's submission must include all of the following:**

- 3.1.1** Signed and completed Bid Form (Attachment A)
- 3.1.2** Signed and completed Price Sheet (Attachment B) in **sealed envelope**
- 3.1.3** A 5% bid bond or certified check must accompany your Bid if Bid price is over \$100,000.00.
- 3.1.4** Project Personnel: Identify key Construction Project Manager.
- 3.1.5** Key Point of Contact: List main point of contact and/or Project Manager.
- 3.1.6** Schedule and Work Plan: Develop a Project Management schedule that shall include all of the construction work activities. Indicate the time-frame for accomplishing the work.
- 3.1.7** Subcontractors: Provide a listing of the subcontractors' names, address and role in this contract.
- 3.1.8** Copy of State of North Carolina General Contractor's License
- 3.1.9** Proof of insurance as required and listed in (Attachment C)
- 3.1.10** E-Verify (Attachment D)
- 3.1.11** Contractor's Statement of Sales/Use Tax (Attachment E)
- 3.1.12** Iran Divestment Certificate (Attachment F)
- 3.1.13** Companies Boycotting Israel Divestment Act Certificate Form (Attachment G)
- 3.1.14** Certificate Regarding Conflict of Interest (Attachment H)
- 3.1.15** Non-Collusion (Attachment I)
- 3.1.16** Federal Clauses (Attachment J)
- 3.1.17** Davis – Bacon Rate Forms (Attachment K)
- 3.1.18** M/WBE Forms (Attachment L)
- 3.1.19** Responsive Checklist (Attachment M)
- 3.1.20** *Contractor shall provide within 5 calendar days from notice of award the following bonds if Bid price is over \$100,000.00:*
  - Time and Material Payment Bond – 100% of the contract price
  - Performance Bond – 100% of contract price

### 3.2 GENERAL BID REQUIREMENTS

For a Bid to be considered, all documents required by this IFB must be submitted in the specified format. The Bid submission should follow the format and order set forth in Section 3.1 above. Submit one (1) original and three (3) additional copies of the Bid, and one USB Flash Drive. All Bids become the property of GoTriangle. GoTriangle will not photocopy your Bid documents for the purpose of complying with this provision requiring duplicate copies. Failure to provide the required number of complete duplicate copies may result in rejection of your Bid. GoTriangle will receive Bids only by personal delivery, courier/delivery service, or regular mail. Bids submitted by facsimile or email will not be accepted. **Bids will be received until 10:00 a.m. and opened at 11:00 a.m. by way of Microsoft Teams:**

#### **Microsoft Teams meeting**

[Join the meeting now](#)

Meeting ID: 279 466 992 345

Passcode: Bjixde

#### **Dial in by phone**

[+1 252-210-4099,,648962518#](#) United States, Rocky Mount

[Find a local number](#)

Phone conference ID: 648 962 518#

The Bid must be submitted to Mr. William Bryant, Procurement Administrator by the time and date indicated above, marked **“IFB 24-012 Go Triangle Construction Group k”**.

**Please acknowledge receipt of any addendum received on bid form.**

Please note the different remit to addresses below, if Contractor chooses to send the Bid by personal delivery, courier/delivery service, or by US mail:

	<b>Delivered By Personal Delivery or Courier/Delivery Service</b>
	GoTriangle 4600 Emperor Blvd Durham, NC 27703

**NO BIDS RECEIVED AFTER THE DATE AND HOUR SET FORTH BELOW WILL BE ACCEPTED OR CONSIDERED. BIDS SENT BY U.S. MAIL THAT ARE NOT RECEIVED IN HAND BY GOTRIANGLE BY THE DEADLINE SET FORTH BELOW WILL NOT BE CONSIDERED.**

There will be a public bid opening (via Microsoft Teams at 11:00 a.m.). IFBs are being solicited under the GoTriangle purchasing policy for “Informal Bids”. “Informal Bids” are kept confidential until a Contract has been awarded. There is no expressed or implied obligation for GoTriangle to reimburse Contractors for any expenses incurred in preparing Bids in response to this IFB

The awarding of the Contract, if awarded, will be made by GoTriangle as soon thereafter as practicable. Contractors not chosen will be notified in electronic correspondence. The Bid Form should be signed by a responsible representative of the company submitting the Bid. Bid Forms that are not signed will not be considered.

### **3.3 CHANGES TO IFB DOCUMENT(ADDENDA)**

Any changes to this IFB document will be made by written addenda issued by GoTriangle. Upon issuance, the addenda will be considered part of the IFB document and will prevail over inconsistent or conflicting provisions contained in the original IFB document. Addenda will be sent electronically via email from the Procurement Administrator. This process will be repeated each time an addendum is posted to the GoTriangle website.

A valid e-mail address must be provided upon requesting the IFB documents in order for GoTriangle to notify Contractors of the availability of addenda. GoTriangle will not be responsible for Contractors failing to receive notification of the availability of addenda if an invalid e-mail address or no e-mail address was provided to GoTriangle.

Contractors shall acknowledge their receipt of all addenda in Bid Form (Attachment B) submitted with their Bid submission. As with other required documentation, Bids that fail to provide a detailed listing of addenda received may be excluded from further consideration for this solicitation.

**A revised due date of Contractor’s Bid (if applicable) shall be stated in each addendum. If you have received this solicitation from a source other than the GoTriangle, it is the Contractor’s responsibility to ensure that all addenda have been received.**

### **3.4 QUESTIONS**

Any questions regarding this IFB should be directed to William Bryant, Interim Procurement Manager. All questions must be submitted in writing before 5:00 p.m. EDST July 24, 2024. Questions will be emailed only to William Bryant at [wbryant@gotriangle.org](mailto:wbryant@gotriangle.org). Responses to questions will be posted on the GoTriangle’s website (<https://gotriangle.org/invitation-bids-ifb>) by 5:00 p.m. EDST on July 26, 2024. All Contractors that have requested previously IFB documents from the GoTriangle website shall be notified of responses via e-mail.



### **3.5 BID OPENING**

GoTriangle Procurement Administrator will open the bids in the presence of bidders' designated representatives who choose to attend, at the time, date and location stipulated in the Bidding Document. The bidders' representatives who are present, shall sign a register evidencing their attendance. Bids not opened and read out at bid opening shall not be considered further for evaluation, irrespective of the circumstances. The Employer shall prepare minutes of the bid opening including the information disclosed to those present.

### **3.6 EXAMINATION OF BIDS AND DETERMINATION OF RESPONSIVENESS**

Information relating to examination, clarification, evaluation and comparison of bids and recommendations for the award of a contract shall not be disclosed to bidders or any other persons, not initially concerned with such process until the award to the successful bidder has been announced. Any effort by a bidder to influence the processing of bids or award decisions may result in the rejection of the bidder's bid.

A substantially responsive bid is one that conforms to all the terms and conditions and specifications of the bidding document without material deviation or reservation. A material deviation or reservation is one which affects in any substantial way the scope, quality, or performance of the work and which limits in any substantial way. Inconsistent with the bidding documents, GoTriangle's rights or the bidder's obligations under the contract, or whose Rectification would affect unfairly the competitive position of other bidders presenting substantially responsive bids.

If a bid is not substantially responsive, it will be rejected by GoTriangle and may not subsequently be made responsive by correction or withdrawal and the non-conforming deviations or reservations.

## **SECTION 4. AWARD CRITERIA**

### **4.1 SELECTION**

Bids will first be reviewed for responsiveness and inclusion of the components specified in **Section 3** for this IFB document. The absence of any required information may result in exclusion from further analysis.

GoTriangle will make the award to the lowest responsive responsible Contractor whose Bid is most advantageous to the GoTriangle.

GoTriangle may waive any irregularities in any Bid that does not prejudice other Contractors. GoTriangle further reserves the right to negotiate when bids exceed budget amount.

### **4.2 SELECTION PROCESS PROTEST PROCEDURES**

Protests made with respect to this IFB shall be submitted to the CEO not later than five (5) business days after the recommendation of award has been announced. The CEO shall provide a written response within but not later than five (5) business days after receiving such protest. GoTriangle's written response and disposition of protest findings shall be deemed final. GoTriangle's CEO shall report all such protests to the Board of Trustees prior to a Contract award.

Any and all protests filed with GoTriangle CEO shall be submitted in writing and:

- a) Include the name and address of the protester.
- b) Identify the procurement by solicitation number and then the current deadline date for receipt of Bids.
- c) Contain a statement of the legal and factual grounds for the protest and any supporting documentation. The grounds for the protest must be fully supported.
- d) Indicate the ruling or relief that protester desires from GoTriangle.

Violations of federal law or regulations will be handled by the complaint process stated within that law or regulation. Violations of state or local law or regulations will be under the jurisdiction of state or local authorities.

### **4.3 ACCEPTANCE OR REJECTION OF BIDS**

Failure to respond to any of the requirements outlined in either the Invitation for Bids or the Bid Form or a failure to enclose or submit any of the required documents may disqualify the Contractor's Bid submission.

GoTriangle has the sole right to select the successful Contractor for award; to reject any and all IFBs and to re-solicit for new IFBs.

IFBs shall be submitted to GoTriangle on the most favorable of terms possible from the standpoint of cost, quality, delivery date and technical capability. No Contractor shall have any cause of action against GoTriangle arising out of the methods by which IFBs are assessed. The selection of the successful Contractor shall be at the sole discretion of GoTriangle.

Submission of a Bid indicates acceptance by the Contractor of the conditions contained in this IFB unless clearly and specifically noted in the Bid submitted and confirmed in the Contract between GoTriangle and the selected Contractor.

**4.4 SCHEDULE OF EVENTS**

<b>DATE</b>	<b>IFB N0: 24-012 Bus Stop Improvements Construction Group K</b>
July 15, 2024	IFB distributed and posted to GoTriangle website
July 23, 2024	<b>Non-Mandatory Pre-Proposal Conference via teleconference</b>
July 24, 2024	<b>Inquires must be received in writing by (e-mail Only) to</b>  <a href="mailto:wbrvant@gotriangle.org">wbrvant@gotriangle.org</a>
July 26, 2024	Responses to all questions received will be posted on the GoTriangle website. All firms that have previously registered and downloaded the IFB documents from the GoTriangle website will be notified of responses via e-mail.
<b>August 15, 2024</b>	<b>Bids are due. There will be a public bid opening by way Microsoft Teams at 11:00 am.</b>
August 23, 2024	Bids Evaluated
TBD, 2024	Review and Selection Committee recommends award to the CEO & President
TBD, 2024	Issue Notice of Intent to Award
TBD	GoTriangle Board of Trustees authorizes the CEO to execute contract with the recommended Submitter.
TBD	Enter into Contract with Awarded Firm

## **SECTION 5. GENERAL BID CONDITIONS**

### **5.1 NOTICE OF FORMAL SOLICITATION**

Notwithstanding any other provision of this IFB, all Contractors are hereby specifically advised that this IFB is a form solicitation for Bids only, and is not intended and it not to be constructed as an offer to enter into an agreement or engage into any formal competitive bidding or negotiation pursuant to any statute, ordinance, rule of regulation.

### **5.2 METHOD OF RESPONSE**

Responses to this IFB shall be made according to the scope of work and instructions contained herein. Failure to adhere to instructions may be cause for rejection of any Bid.

### **5.3 ACCEPTANCE OF TERMS AND CONDITIONS**

Contractors understand and agree that submission of a Bid will constitute acknowledgment and acceptance of, and a willingness to comply with, all the terms, conditions, and criteria contained in this IFB, except as otherwise specified in the Bid. Any and all parts of the submitted Bids may become part of any subsequent Agreement between the selected Contractor and GoTriangle.

### **5.4 FALSE, INCOMPLETE OR UNRESPONSIVE STATEMENTS**

False, incomplete, or unresponsive statements in connection with a Bid may be sufficient cause for rejection of the Bid. The evaluation and determination of the fulfillment of the above requirement will be GoTriangle's responsibility and its judgment shall be final.

### **5.5 CLEAR AND CONCISE SUBMISSION**

Bids shall provide a straightforward, concise delineation of the Contractor's capability to satisfy the requirements of the IFB. Each Bid shall be submitted in the requested format and provide all required information. **Each Bid shall be signed in ink by a duly authorized officer of the company.**

### **5.6 PRIME CONTRACTOR RESPONSIBILITIES**

The selected Contractor will be required to assume responsibility for all requested deliverables as indicated in Section 2 regardless of who produces them. Further, GoTriangle will consider the selected Prime Contractor to be the sole point of contact with regard to contractual matters, including payment of any and all charges resulting from the contract. Contractor and/or subcontractor shall give a copy of their State of North Carolina Contractor License and permits from governmental agencies as required upon notification of award. The Prime Contractor agrees to pay each Subcontractor under this prime contract for satisfactory performance of its contract no later than 30 days from the receipt of each payment the Prime Contractor receives from GoTriangle. Any delay or postponement of payment from the above referenced time frame may occur only for good cause following written approval of GoTriangle. The clause applies to both DBE and non-DBE subcontracts.

#### **Retainage:**

The Prime Contractor agrees to return retainage payments to each subcontractor within 30 days after the Subcontractors work is satisfactory completed. Any delay or postponement of payment from the above referenced time frame may occur only for good cause following written approval of GoTriangle. This clause applies to both DBE and non-DBE subcontracts.

## **SECTION 6. ATTACHMENTS**

### **PLEASE REFER TO THE FOLLOWING ATTACHMENTS:**

Attachment A – Vendor Information Form

Attachment B – Bid Price Form

Attachment C – Minimum Insurance Requirement

Attachment D – E-Verify Form

Attachment E – Contractor’s Statement of Sales/Use Tax

Attachment F – Iran Divestment Act Certificate

Attachment G – Companies Boycotting Israel Divestment ACT Certification Form

Attachment H – Certificate Regarding Conflict of Interest

Attachment I – Non-Collusion

Attachment J – Federal Clauses

Attachment K – Davis-Bacon Rate Forms

Attachment L- M/WBE Forms

Attachment M – RFP Responses Checklist

Attachment – Bid Exhibit Documents

A. Exhibit A GoTriangle Construction\_Group K\_Base\_Bid\_Plans\_2024-04-08

B. Exhibit B – GoTriangle Group K Technical Specifications\_2024-04-04

**Attachment-A**

\_\_\_\_\_  
**Firm's Legal Name/Address:** \_\_\_\_\_ **Date Prepared:** \_\_\_\_\_  
\_\_\_\_\_  
**Date Firm Established:** \_\_\_\_\_  
\_\_\_\_\_  
**Principal to Contact/Title:** \_\_\_\_\_  
\_\_\_\_\_  
**Business Telephone:** \_\_\_\_\_  
\_\_\_\_\_  
**Business Email:** \_\_\_\_\_

Is this address the:  Main Office  Regional Office  Branch Office  Other \_\_\_\_\_

**Former Firm Name(s), if any.**      **Year Established**      **Name/Address/Telephone of Parent Company, if any**



**Corporate Structure:**

Sole Proprietorship     Corporation     Joint Venture  
 Parent Company         Partnership     Other (specify):\_\_

**Other offices of the firm:**

City/State      Telephone No.      No. of personnel      Identify home office with \*

\_\_\_\_\_  
\_\_\_\_\_

1. State of Incorporation: \_\_\_\_\_
2. State of North Carolina Registration#: \_\_\_\_\_
3. Federal Tax Identification#: \_\_\_\_\_
4. Acknowledge Addendum(a) by specifying Addendum(a) in spaces provided: \_\_\_\_\_
5. North Carolina Contractor's License Number \_\_\_\_\_

DBE: Yes      No

---

**Certification**

The undersigned prime Bidder certifies that, to the best of his/her knowledge, the information presented in this Invitational for Bid is a statement of facts and that the firm has the financial capability to perform the work being applied for. The undersigned prime Bidder further certifies that it knows of no personal and/or organizational conflict of interest prohibited under federal, state, and local law.

I certify (or declare) under penalty of perjury under the laws of the State of North Carolina that the foregoing is true and correct.

Signature

Name:

\_\_\_\_\_

Title:

\_\_\_\_\_

Date:

\_\_\_\_\_

Place:

\_\_\_\_\_

(City and State)

**END OF FORM**

# Attachment B Bid Form

GoDurham Bus Stop Improvements - Multiple Sites - Construction Group K

## ITEMIZED PROPOSAL / SCHEDULE OF PRICES - BASE BID

GoTriangle Bus Stop Improvements - Multiple Sites - Construction Group K

Addition of bus stop and site amenities to bus stop locations generally consisting of grading, concrete pads and sidewalks, installing amenities, and other related items.

= FILL OUT INFORMATION FOR UNIT BID AND AMOUNT BID

= NOT APPLICABLE FOR SECTION

Item No.	Item Description	Unit	Quantity	Unit Bid Price	Amount Bid
1	MOBILIZATION/TRAVEL TIME	LS	1		
2	DEMOLITION	LS	1		
3	EARTHWORK	LS	1		
4	EROSION CONTROL	LS	1		
5	TRAFFIC CONTROL	LS	1		
6	SIGNAL BOX & LOOP ADJUSTMENT	LS	1		
7	GRASS SOD / MULCH	SF	1820		
8	4" SIDEWALK	SF	35		
9	6" SIDEWALK	SF	1445		
10	6" CONCRETE PAD	SF	855		
11	BRICK PAVERS	SF	200		
12	INSTALL SHELTER	EA	6		
13	INSTALL SIMME-SEAT	EA	1		
14	INSTALL BENCH	EA	2		
15	INSTALL BIKE RACK	EA	4		
16	RELOCATE SIGN	EA	10		
17	ADJUST UTILITY BOX/VAULT	EA	1		
18	INSTALL BUS STOP SECURITY LIGHTING SYSTEM	EA	6		
19	HANDRAIL	LF	12		
20	RELOCATE MAILBOX	EA	1		
				<b>BASE BID SUBTOTAL</b>	
				<b>10% CONTINGENCY OF BASE BID SUBTOTAL</b>	
				<b>BASE BID TOTAL</b>	
				<b>(=BASE BID SUBTOTAL + 10% CONTINGENCY)</b>	

**NOTE:** ALL UNIT PRICES, EXTENSIONS, AND TOTAL BID AMOUNTS ARE MANDATORY. OMISSION OF ANY PRICES, EXTENSIONS, OR TOTAL BID AMOUNTS SHALL RESULT IN THE REJECTION OF THE BID. UNIT PRICES FOR ADD ALTERNATE ITEMS SHALL BE THE SAME AS THOSE LISTED ON THE BASE BID, EXCEPT FOR ITEMS TO PAID BY LUMP SUM. THE UNIT PRICES FOR THE ITEMS IN THE CONTRACT ARE FOR FURNISHING, INSTALLING, COMPLETING, HAVING IN PLACE, AND BEING ACCEPTED.

CONTRACTOR: \_\_\_\_\_

LICENSE NO.: \_\_\_\_\_

SIGNATURE: \_\_\_\_\_

DATE: \_\_\_\_\_



**Attachment C to GoTriangle Contract No. 24-012**  
**Minimum Insurance Requirements**

1. Definitions. "Contractor" as used in this Exhibit shall mean: \_\_\_\_\_ "GoTriangle" as used in this Exhibit shall mean the Research Triangle Regional Public Transportation Authority dba GoTriangle. "Contract" as used in this Exhibit shall mean the agreement or contract to which this Exhibit is attached.
2. General Terms. Contractor shall secure and maintain at its own expense each type of insurance, with the applicable minimum coverage limits, as specified in this Exhibit. Contractor shall secure the required insurance policies prior to performing any work, activity, or service under this Contract. Contractor shall maintain such policies throughout the term of this Contract, unless a longer period is required pursuant to the provisions herein. Any insurance carried by Contractor is primary insurance and shall not be considered contributory with any insurance carried by GoTriangle. In the event that any portion of Contractor's obligations under this Contract are subcontracted by Contractor, then Contractor shall require each subcontractor to secure and maintain insurance satisfying the requirements of this Exhibit, or in the alternative, Contractor may secure and maintain the insurance on the subcontractor's behalf. The insurance requirements set forth in this Exhibit do not modify or otherwise relieve Contractor of Contractor's other obligations as stated elsewhere in this Contract.
3. Commercial General Liability. Contractor shall secure and maintain occurrence-form Commercial General Liability insurance, including coverage for premises and operations, products and completed operations, independent contractors, personal injury and blanket contractual liability, with limits of not less than: General Aggregate (\$2 million); Products and Completed Operations Aggregate (\$2 million); Personal and Advertising Injury Aggregate (\$1 million); and Each Occurrence (\$1 million). Such insurance shall be primary and non-contributory with any insurance carried by GoTriangle.
4. Worker's Compensation and Employer's Liability. Contractor shall secure and maintain Worker's Compensation insurance complying with North Carolina statutory requirements covering all employees and owners, and including Employer's Liability coverage with limits of not less than \$1 million per accident, \$1 million disease per policy limit, and \$1 million disease per employee limit. Coverage shall extend to all states in which operations are conducted.
5. Automobile Liability. Contractor shall secure and maintain Automobile Liability insurance with a limit of not less than \$1 million combined single limit. Such insurance shall include coverage for all owned, hired, and non-owned motorized vehicles both on and off the project site. Such insurance shall be primary and non-contributory with any insurance carried by GoTriangle.
6. Umbrella/Excess Liability. Contractor shall secure and maintain Umbrella or Excess Liability insurance on a "following form" basis with a limit of not less than \$1 million providing excess coverage over and above Contractor's primary insurance for Commercial General Liability, Automobile Liability, and Employer's Liability. Such insurance shall be primary and non-contributory with any insurance carried by GoTriangle.
7. Professional Liability. Contractor shall secure and maintain Professional Liability insurance providing coverage for errors or omissions committed in the course of Contractor's performance under this Contract. The coverage shall be maintained during the term of this Contract and for at least 3 years

following completion of Contractor's performance. The policy shall have limits of not less than \$5 million per claim and in the annual aggregate. The policy may contain a deductible of a maximum of \$250,000, but in such case the deductible shall be the sole responsibility of Contractor, and no portion of the deductible is the responsibility of GoTriangle.

8. Privacy and Network Liability (Cyber). Contractor shall secure and maintain Privacy and Network Liability (Cyber) insurance with a limit of not less than \$5 million aggregate and providing coverage for network security, third party liability, notification services, and cyberextortion.

9. Other Terms.

9.1. Qualified Insurers. Contractor shall secure and maintain the required insurance policies from insurance carriers authorized to conduct business in the State of North Carolina with a current A.M. Best rating of "A-" or better.

9.2. Waiver of Subrogation. The following policies of insurance shall include a waiver of subrogation in favor of Research Triangle Regional Public Transportation Authority dba GoTriangle: Commercial General Liability; Worker's Compensation and Employer's Liability; Automobile Liability; and Umbrella/Excess.

9.3. Additional Insured. The following policies of insurance shall name Research Triangle Regional Public Transportation Authority dba GoTriangle as an additional insured: Commercial General Liability; Automobile Liability; and Umbrella/Excess Liability.

9.4. Notice to GoTriangle. If any required coverage lapses for any reason, Contractor shall provide immediate written notice to GoTriangle. Each policy shall also contain notification provisions whereby GoTriangle will receive not less than 30 days' written notice prior to the cancellation of the policy.

9.5. Claims-made Insurance. If any insurance policy required by this Exhibit is secured on a claims-made basis, then such policy shall provide that:

9.5.1. The retroactive date shall coincide with or precede Contractor's commencement of performance under this Contract (including subsequent policies purchased as renewals or replacements);

9.5.2. The policy shall allow for the reporting of circumstances or incidents that might give rise to future claims;

9.5.3. Contractor shall maintain similar insurance under the same terms and conditions for at least 3 years following completion of all performance under this Contract; and

9.5.4. If insurance is terminated for any reason, Contractor shall purchase an extended reporting provision of at least 2 years to report claims arising from Contractor's performance.

- 9.6. Deductibles and Self-insured Retention. GoTriangle will review all deductible and self-insured retention (SIR) amounts and may require Contractor to secure alternate insurance when in GoTriangle's sole discretion such amounts are not reasonable under the circumstances. The payment of any deductible is the sole responsibility of Contractor.
- 9.7. Certificates of Insurance. Before commencing performance under this Contract, for each required policy Contractor shall furnish a certificate of insurance (COi) to GoTriangle that demonstrates coverage in compliance with the requirements of this Exhibit and includes the following:
- 9.7.1. Effective and expiration dates of the policy
  - 9.7.2. Amount of any deductible or self-insured retention
  - 9.7.3. Any exclusions to the policy which are not part of the standard form
  - 9.7.4. Reference to GoTriangle Contract Number identified on the first page of this Exhibit
  - 9.7.5. Title block formatted as follows: **Research Triangle Regional Public Transportation Authority dba GoTriangle, PO Box 13787, Research Triangle Park, NC27709****

## Attachment D- E-Verify Form

### GOTRIANGLE E-VERIFY EMPLOYER COMPLIANCE STATEMENT

#### E-Verify for Public Contracts: HB 786 (S.L. 2013-418)

The legislation referenced prohibits governmental units from awarding to or entering into contracts unless the contractor and the contractor's subcontractors comply with the E-Verify requirements of Article 2 of Chapter 64 of the NC General Statutes.

Contractor, hereafter Employer, understands that E-Verify is a federal program operated by the United States Department of Homeland Security and other federal agencies, or any successor or equivalent program used to verify the work authorization of newly hired employees pursuant to federal law. Employer is defined as: Any person, business entity, or other organization that transacts business in

this State and that employs 25 or more employees in this State. This term does not include State agencies, counties, municipalities, or other governmental bodies.

Employer understands that Employers, as Defined Herein, Must Use E-Verify. Each employer, after hiring an employee to work in the United States, shall verify the work authorization of the employee through E-Verify in accordance with NCGS§64-26(a).

Therefore, all employers must be in compliance with the E-Verify requirements to enter into contracts with Triangle Transit.

**Below check the type of employer and complete the information.**

A) **Employer with less than 25 employees**, not required to use E-Verify: \_\_\_\_\_

Company Name: \_\_\_\_\_

Name and title of Authorized Signer(s): \_\_\_\_\_

Date: \_\_\_\_\_

**OR:**

B) **Employer with 25 or more employees** required by NC S.L.213-418 to use E-Verify:  
**Yes, we comply:**

Company Name: \_\_\_\_\_

Name and title of Authorized Signer(s): \_\_\_\_\_

Date: \_\_\_\_\_

**ATTACHMENT E**

**Contractor's Statement of Sales/Use Tax Paid**  
**Sales and Use Taxes Paid on Materials Purchased for the Construction of the**

---

Invoice Date	Invoice Number	Company Name	Type of Material Purchased	Cost of Material	Amount of Sales/Use Tax Paid	County Where Sales/Use Tax Paid
Total				\$0.00	\$0.00	

## Attachment - G

### Companies Boycotting Israel Divestment Act Certification Form

RFP/RFQ Number (if applicable): \_\_\_\_\_

Name of Contracting Party or Bidder: \_\_\_\_\_

\_\_\_\_\_

#### **COMPANIES BOYCOTTING ISRAEL DIVESTMENT ACT CERTIFICATION REQUIRED BY N.C.G.S. §147-86.81et seq. \***

Pursuant to N.C.G.S. §147-86.81, any person identified as engaging in a boycott of Israel, as defined by this Act. In addition, State agencies must divest from investments in such restricted companies, determined by appearing on the Final Divestment List created by the State Treasurer pursuant to G.S. 147-86.81, is ineligible to contract with the State of North Carolina or any political subdivision of the State.

As of the date listed below, the supplier or bidder listed above is not listed on the Final Divestment List created by the State Treasurer pursuant to N.C.G.S. §147-86.81.

The undersigned hereby certifies that he or she is authorized by the contracting party or bidder listed above to make the foregoing statement.

---

Signature

Date

---

Printed Name

Title

N.C.G.S. §147-86.81 requires this certification for bids or contracts with the State of North Carolina, a North Carolina local government, or any other political subdivision of the State of North Carolina. The certification is required at the following times:

- When a bid is submitted
- When a contract is entered into (if the certification was not already made when the vendor made its bid)
- When a contract is renewed or assigned

N.C.G.S. § 147-86.81(b) requires that contractors with the State, a North Carolina local government, or any other political subdivision of the State of North Carolina must not utilize any subcontractor found on the State Treasurer's Final Divestment List.

The State Treasurer's Final Divestment List can be found on the State Treasurer's website at: <https://www.nctreasurer.com/inside-the-department/OpenGovernment/Pages/Divestment-Acts-Resources.aspx> and will be updated every 180 days.

\* Note: Enacted by Session Law 2017-193 as N.C.G.S. §147-86.81et seq.

## Attachment - G

### Companies Boycotting Israel Divestment Act Certification Form

RFP/RFQ Number (if applicable): \_\_\_\_\_

Name of Contracting Party or Bidder: \_\_\_\_\_  
\_\_\_\_\_

#### **COMPANIES BOYCOTTING ISRAEL DIVESTMENT ACT CERTIFICATION REQUIRED BY N.C.G.S. §147-86.81et seq. \***

Pursuant to N.C.G.S. §147-86.81, any person identified as engaging in a boycott of Israel, as defined by this Act. In addition, State agencies must divest from investments in such restricted companies, determined by appearing on the Final Divestment List created by the State Treasurer pursuant to G.S. 147-86.81, is ineligible to contract with the State of North Carolina or any political subdivision of the State.

As of the date listed below, the supplier or bidder listed above is not listed on the Final Divestment List created by the State Treasurer pursuant to N.C.G.S. §147-86.81.

The undersigned hereby certifies that he or she is authorized by the contracting party or bidder listed above to make the foregoing statement.

---

Signature

Date

---

Printed Name

Title

N.C.G.S. §147-86.81 requires this certification for bids or contracts with the State of North Carolina, a North Carolina local government, or any other political subdivision of the State of North Carolina. The certification is required at the following times:

- When a bid is submitted
- When a contract is entered into (if the certification was not already made when the vendor made its bid)
- When a contract is renewed or assigned

N.C.G.S. § 147-86.81(b) requires that contractors with the State, a North Carolina local government, or any other political subdivision of the State of North Carolina must not utilize any subcontractor found on the State Treasurer's Final Divestment List.

The State Treasurer's Final Divestment List can be found on the State Treasurer's website at: <https://www.nctreasurer.com/inside-the-department/OpenGovernment/Pages/Divestment-Acts-Resources.aspx> and will be updated every 180 days.

\* Note: Enacted by Session Law 2017-193 as N.C.G.S. §147-86.81et seq.

**Attachment H**



**CERTIFICATION REGARDING CONFLICT OF INTEREST**

The Submitter is required to certify that performance of the work will not create any conflicts of interest or disclose any actual or potential conflicts of interest by completing and signing one of the following statements:

---

The Submitter hereby certifies that to the best of its knowledge and belief, and in accordance with GoTriangle’s “Procedures and Guidelines for Preventing Organizational Conflicts of Interest and RFP Section 2 performance of the services described in the Scope of Work will not create any conflicts of interest for the Submitter, any affiliates, any proposed subconsultants, and key personnel of any of these organizations.

DATE: \_\_\_\_\_

AUTHORIZED SIGNATURE: \_\_\_\_\_

TITLE: \_\_\_\_\_

SUBMITTER/COMPANY NAME: \_\_\_\_\_

**OR**

---

The Submitter hereby discloses the following circumstances that could give rise to a conflict of interest for the Submitter, any affiliates, any proposed subconsultants, and key personnel of any of these organizations. (Attach additional sheets as needed.)

Name of the Individual/Company to which potential conflict of interest might apply:

\_\_\_\_\_

Nature of potential conflict of interest:

\_\_\_\_\_

\_\_\_\_\_

\_\_\_\_\_



## Attachment H

Proposed Remedy:

---

---

---

---

DATE: \_\_\_\_\_

AUTHORIZED SIGNATURE: \_\_\_\_\_

TITLE: \_\_\_\_\_

SUBMITTER/COMPANY NAME: \_\_\_\_\_

## Attachment I

### PROPOSER STATEMENT OF NON-COLLUSION

**BY SUBMISSION OF THIS PROPOSAL, PROPOSER AND EACH PERSON SIGNING ON BEHALF OF PROPOSER CERTIFIES AS TO ITS OWN ORGANIZATION, UNDER PENALTY OF PERJURY, THAT TO THE BEST OF HIS/HER KNOWLEDGE AND BELIEF:**

- (1) The prices of this proposal have been arrived at independently, without collusion, consultation, communication, or agreement with any other Proposer or competitor, for the purposes of restricting competition or as to any matter relating to price.
- (2) Unless otherwise required by law, the prices quoted in this proposal have not been knowingly disclosed by Proposer and will not be disclosed by Proposer directly or indirectly to any other Proposer or competitor before proposals are opened.
- (3) No attempt has been made or will be made by the Proposer to induce any other person, partnership or corporation to submit or not to submit a bid on any portion of the Project work.

**IF, FOR ANY REASON, PROPOSER CANNOT CERTIFY AS SET FORTH ABOVE, PROPOSER SHALL SO STATE AND SET FORTH THE REASONS IN DETAIL BELOW:**

Subscribed to under penalty of perjury under the laws of the State of North Carolina, this \_\_\_\_\_ day of \_\_\_\_\_, 20\_\_\_\_ as the act and deed of said corporation or partnership.

---

Name (print):

Title:

Company:

Attachment J

# Federal Clauses

## ACCESS TO RECORDS AND REPORTS

- a. Record Retention. The Contractor will retain, and will require its subcontractors of all tiers to retain, complete and readily accessible records related in whole or in part to the contract, including, but not limited to, data, documents, reports, statistics, sub-Contracts, leases, subcontracts, arrangements, other third party Contracts of any type, and supporting materials related to those records.
- b. Retention Period. The Contractor agrees to comply with the record retention requirements in accordance with 2 C.F.R. § 200.333. The Contractor shall maintain all books, records, accounts and reports required under this Contract for a period of at not less than three (3) years after the date of termination or expiration of this Contract, except in the event of litigation or settlement of claims arising from the performance of this Contract, in which case records shall be maintained until the disposition of all such litigation, appeals, claims or exceptions related thereto.
- c. Access to Records. The Contractor agrees to provide sufficient access to FTA and its contractors to inspect and audit records and information related to performance of this contract as reasonably may be required.
- d. Access to the Sites of Performance. The Contractor agrees to permit FTA and its contractors access to the sites of performance under this contract as reasonably may be required.

## AMERICANS WITH DISABILITIES ACT(ADA)

The contractor agrees to comply with the requirements of 49 U.S.C. § 5301 (d), which states the Federal policy that the elderly and persons with disabilities have the same right as other persons to use mass transportation service and facilities, and that special efforts shall be made in planning and designing those services and facilities to implement that policy. The contractor also agrees to comply with all applicable requirements of section 504 of the Rehabilitation Act of 1973, as amended, 29 U.S.C. § 794, which prohibits discrimination on the basis of handicaps, with the Americans with Disabilities Act of 1990 (ADA), as amended, 42 U.S.C. §§ 12101 et seq., which requires that accessible facilities and services be made available to persons with disabilities, including any subsequent amendments to that Act, and with the Architectural Barriers act of 1968, as amended, 42 U.S.C. §§ 4151 et seq., which requires that buildings and public accommodations be accessible to persons with disabilities, including any subsequent amendments to that Act. In addition, the contractor agrees to comply with any and all applicable requirements issued by the FTA, DOT, DOJ, U.S. GSA, U.S. EEOC, U.S. FCC, any subsequent amendments thereto and any other nondiscrimination statute(s) that may apply to the Project.

## BYRD ANTI-LOBBYING AMENDMENT

Contractors who apply or bid for an award of \$100,000 or more shall file the required certification. Each tier certifies to the tier above that it will not and has not used Federal appropriated funds to pay any person or organization for influencing or attempting to influence an officer or employee of any agency, a member of Congress, officer or employee of Congress, or an employee of a member of Congress in connection with obtaining any Federal contract, grant, or any other award covered by 31 U.S.C. § 1352. Each tier shall also disclose any lobbying with non-Federal funds that takes place in connection with obtaining any Federal award. Such disclosures are forwarded from tier to tier up to the Agency.”

## BOND REQUIREMENTS

**Bid Guarantee.** Bidders shall furnish a bid guaranty in the form of a bid bond, or certified treasurer's or cashier's check issued by a responsible bank or trust company, made payable to the Agency. The amount of such guaranty shall be equal to the value or a percentage of the total bid price.

In submitting this bid, it is understood and agreed by bidder that the Agency reserves the right to reject any and all bids, or part of any bid, and it is agreed that the Bid may not be withdrawn for a period of [90] days subsequent to the opening of bids, without the written consent of Agency.

It is also understood and agreed that if the undersigned bidder should withdraw any part or all of their bid within [90] days after the bid opening without the written consent of the Agency, or refuse or be unable to enter into this Contract as provided above, or refuse or be unable to furnish adequate and acceptable Performance and Payment Bonds, or refuse or be unable to furnish adequate and acceptable insurance, as provided above, it shall forfeit its bid guaranty to the extent Agency's damages occasioned by such withdrawal, or refusal, or inability to enter into a Contract, or provide adequate security thereof.

It is further understood and agreed that to the extent the defaulting bidder's bid guaranty shall prove inadequate to fully recompense Agency for the damages occasioned by default, then the undersigned bidder agrees to indemnify Agency and pay over to Agency the difference between the bid guarantee and Agency's total damages so as to make Agency whole.

The undersigned understands that any material alteration of any of the above or any of the material contained herein, other than that requested will render the bid unresponsive.

**Performance Guarantee.** A Performance Guarantee in the amount of 100% of the Contract value is required by the Agency to ensure faithful performance of the Contract. Either a Performance Bond or an Irrevocable Stand-By Letter of Credit shall be provided by the Contractor and shall remain in full force for the term of the Contract. The successful Bidder shall certify that it will provide the requisite Performance Guarantee to the Agency within ten (10) business days from Contract execution. The Agency requires all Performance Bonds to be provided by a fully qualified surety company acceptable to the Agency and listed as a company currently authorized under 31 C.F.R. part 22 as possessing a Certificate of Authority as described hereunder. Agency may require additional performance bond protection when the contract price is increased. The increase in protection shall generally equal 100 percent of the increase in contract price. The Agency may secure additional protection by directing the Contractor to increase the amount of the existing bond or to obtain an additional bond.

If the Bidder chooses to provide a Letter of Credit as its Performance Guarantee, the Bidder shall furnish with its bid, certification that an Irrevocable Stand-By Letter of Credit will be furnished should the Bidder become the successful Contractor. The Bidder shall also provide a statement from the banking institution certifying that an Irrevocable Stand-By Letter of Credit for the action will be provided if the Contract is awarded to the Bidder. The Irrevocable Stand-By Letter of Credit will only be accepted by the Agency if:

1. A bank in good standing issues it. The Agency will not accept a Letter of Credit from an entity other than a bank.
2. It is in writing and signed by the issuing bank.
3. It conspicuously states that it is an irrevocable, non-transferable, "standby" Letter of Credit.
4. The Agency is identified as the Beneficiary.
5. It is in an amount equal to 100% of the Contract value. This amount must be in U.S. dollars.

6. The effective date of the Letter of Credit is the same as the effective date of the Contract
7. The expiration date of the Letter of Credit coincides with the term of the contract.
8. It indicates that it is being issued in order to support the obligation of the Contractor to perform under the Contract. It must specifically reference the Contract between the Agency and the Contractor the work stipulated herein.

The issuing bank's obligation to pay will arise upon the presentation of the original Letter of Credit and a certificate and draft to the issuing bank's representative at a location and time to be determined by the parties. This documentation will indicate that the Contractor is in default under the Contract.

Payment Bonds. A Labor and Materials Payment Bond equal to the full value of the contract must be furnished by the contractor to Agency as security for payment by the Contractor and subcontractors for labor, materials, and rental of equipment. The bond may be issued by a fully qualified surety company acceptable to (Agency) and listed as a company currently authorized under 31 C.F.R. part 223 as possessing a Certificate of Authority as described thereunder.

## **BUY AMERICA REQUIREMENTS**

The contractor agrees to comply with 49 U.S.C. 5323(j) and 49 C.F.R. part 661 and 2 CFR § 200.322 Domestic preferences for procurements, which provide that Federal funds may not be obligated unless all steel, iron, and manufactured products used in FTA funded projects are produced in the United States, unless a waiver has been granted by FTA or the product is subject to a general waiver. General waivers are listed in 49 C.F.R. § 661.7. Separate requirements for rolling stock are set out at 49 U.S.C. 5323(j)(2)(C), 49 U.S.C. § 5323(u) and 49 C.F.R. § 661.11. The bidder or offeror must submit to the Agency the appropriate Buy America certification. Bids or offers that are not accompanied by a completed Buy America certification will be rejected as nonresponsive.

## **CLEAN AIR ACT AND FEDERAL WATER POLLUTION CONTROL ACT**

The Contractor agrees to comply with all applicable standards, orders, or regulations issued pursuant to the Clean Air Act (42 U.S.C. § 7401-7671q) and the Federal Water Pollution Control Act as amended (33 U.S.C. § 1251-1387). Violations must be reported to FTA and the Regional Office of the Environmental Protection Agency. The following applies for contracts of amounts in excess of \$150,000:

### Clean Air Act

- (1) The contractor agrees to comply with all applicable standards, orders or regulations issued pursuant to the Clean Air Act, as amended, 42 U.S.C. § 7401 et seq.
- (2) The contractor agrees to report each violation to the Agency and understands and agrees that the Agency will, in turn, report each violation as required to assure notification to the Agency, Federal Emergency Management Agency, and the appropriate Environmental Protection Agency Regional Office.
- (3) The contractor agrees to include these requirements in each subcontract exceeding \$150,000 financed in whole or in part with Federal assistance provided by FTA.

### Federal Water Pollution Control Act

- (1) The contractor agrees to comply with all applicable standards, orders or regulations issued pursuant to the Federal Water Pollution Control Act, as amended, 33 U.S.C. 1251 et seq.
- (2) The contractor agrees to report each violation to the Agency and understands and agrees that the Agency will, in turn, report each violation as required to assure notification to the Agency, Federal Emergency Management Agency, and the appropriate Environmental Protection Agency Regional Office.
- (3) The contractor agrees to include these requirements in each subcontract exceeding \$150,000 financed in whole or in part with Federal assistance provided by FTA."

## **CARGO PREFERENCE REQUIREMENTS**

The contractor agrees:

- a. to use privately owned United States-Flag commercial vessels to ship at least 50 percent of the gross tonnage (computed separately for dry bulk carriers, dry cargo liners, and tankers) involved, whenever shipping any equipment, material, or commodities pursuant to the underlying contract to the extent such vessels are available at fair and reasonable rates for United States-Flag commercial vessels;
- b. to furnish within 20 working days following the date of loading for shipments originating within the United States or within 30 working days following the date of loading for shipments originating outside the United States, a legible copy of a rated, "on-board" commercial ocean bill-of-lading in English for each shipment of cargo described in the preceding paragraph to the Division of National Cargo, Office of Market Development, Maritime Administration, Washington, DC 20590 and to the FTA Recipient (through the contractor in the case of a subcontractor's bill-of-lading.); and
- c. to include these requirements in all subcontracts issued pursuant to this contract when the subcontract may involve the transport of equipment, material, or commodities by ocean vessel.

## **CIVIL RIGHTS LAWS AND REGULATIONS**

The following Federal Civil Rights laws and regulations apply to all contracts.

**1 Federal Equal Employment Opportunity (EEO) Requirements.** These include, but are not limited to:

- a) Nondiscrimination in Federal Public Transportation Programs. 49 U.S.C. § 5332, covering projects, programs, and activities financed under 49 U.S.C. Chapter 53, prohibits discrimination on the basis of race, color, religion, national origin, sex (including sexual orientation and gender identity), disability, or age, and prohibits discrimination in employment or business opportunity.
- b) Prohibition against Employment Discrimination. Title VII of the Civil Rights Act of 1964, as amended, 42 U.S.C. § 2000e, and Executive Order No. 11246, "Equal Employment Opportunity," September 24, 1965, as amended, prohibit discrimination in employment on the basis of race, color, religion, sex, or national origin.

**2 Nondiscrimination on the Basis of Sex.** Title IX of the Education Amendments of 1972, as amended, 20 U.S.C. § 1681 et seq. and implementing Federal regulations, "Nondiscrimination on the Basis of Sex in Education Programs or Activities Receiving Federal Financial Assistance," 49 C.F.R. part 25

prohibit discrimination on the basis of sex.

**3 Nondiscrimination on the Basis of Age.** The "Age Discrimination Act of 1975," as amended, 42 U.S.C. § 6101 et seq., and Department of Health and Human Services implementing regulations, "Nondiscrimination on the Basis of Age in Programs or Activities Receiving Federal Financial Assistance," 45 C.F.R. part 90, prohibit discrimination by participants in federally assisted programs against individuals on the basis of age. The Age Discrimination in Employment Act (ADEA), 29 U.S.C. § 621 et seq., and Equal Employment Opportunity Commission (EEOC) implementing regulations, "Age Discrimination in Employment Act," 29 C.F.R. part 1625, also prohibit employment discrimination against individuals age 40 and over on the basis of age.

**4 Federal Protections for Individuals with Disabilities.** The Americans with Disabilities Act of 1990, as amended (ADA), 42 U.S.C. § 12101 et seq., prohibits discrimination against qualified individuals with disabilities in programs, activities, and services, and imposes specific requirements on public and private entities. Third party contractors must comply with their responsibilities under Titles I, II, III, IV, and V of the ADA in employment, public services, public accommodations, telecommunications, and other provisions, many of which are subject to regulations issued by other Federal agencies.

#### **Civil Rights and Equal Opportunity**

The Agency is an Equal Opportunity Employer. As such, the Agency agrees to comply with all applicable Federal civil rights laws and implementing regulations. Apart from inconsistent requirements imposed by Federal laws or regulations, the Agency agrees to comply with the requirements of 49 U.S.C. § 5323(h) (3) by not using any Federal assistance awarded by FTA to support procurements using exclusionary or discriminatory specifications. Under this Contract, the Contractor shall at all times comply with the following requirements and shall include these requirements in each subcontract entered into as part thereof.

**1. Nondiscrimination.** In accordance with Federal transit law at 49 U.S.C. § 5332, the Contractor agrees that it will not discriminate against any employee or applicant for employment because of race, color, religion, national origin, sex, disability, or age. In addition, the Contractor agrees to comply with applicable Federal implementing regulations and other implementing requirements FTA may issue.

**2. Race, Color, Religion, National Origin, Sex.** In accordance with Title VII of the Civil Rights Act, as amended, 42 U.S.C. § 2000e et seq., and Federal transit laws at 49 U.S.C. § 5332, the Contractor agrees to comply with all applicable equal employment opportunity requirements of U.S. Department of Labor (U.S. DOL) regulations, "Office of Federal Contract Compliance Programs, Equal Employment Opportunity, Department of Labor," 41 C.F.R. chapter 60, and Executive Order No. 11246, "Equal Employment Opportunity in Federal Employment," September 24, 1965, 42 U.S.C. § 2000e note, as amended by any later Executive Order that amends or supersedes it, referenced in 42 U.S.C. § 2000e note. The Contractor agrees to take affirmative action to ensure that applicants are employed, and that employees are treated during employment, without regard to their race, color, religion, national origin, or sex (including sexual orientation and gender identity). Such action shall include, but not be limited to, the following: employment, promotion, demotion or transfer, recruitment or recruitment advertising, layoff or termination; rates of pay or other forms of compensation; and selection for training, including apprenticeship. In addition, the Contractor agrees to comply with any implementing requirements FTA may issue.

**3. Age.** In accordance with the Age Discrimination in Employment Act, 29 U.S.C. §§ 621-634, U.S. Equal Employment Opportunity Commission (U.S. EEOC) regulations, "Age Discrimination in Employment Act," 29 C.F.R. part 1625, the Age Discrimination Act of 1975, as amended, 42 U.S.C. § 6101 et seq., U.S. Health and Human Services regulations, "Nondiscrimination on the Basis of Age in Programs or Activities Receiving Federal Financial Assistance," 45 C.F.R. part 90, and Federal transit law at 49 U.S.C. § 5332, the Contractor agrees to refrain from discrimination against present and prospective employees for reason of age. In addition, the Contractor agrees to comply with any implementing requirements FTA may issue.

**4. Disabilities.** In accordance with section 504 of the Rehabilitation Act of 1973, as amended, 29 U.S.C. § 794, the Americans with Disabilities Act of 1990, as amended, 42 U.S.C. § 12101 et seq., the Architectural Barriers Act of 1968, as amended, 42 U.S.C. § 4151 et seq., and Federal transit law at 49 U.S.C. § 5332, the Contractor agrees that it will not discriminate against individuals on the basis of disability. In addition, the Contractor agrees to comply with any implementing requirements FTA may issue.

**5. Promoting Free Speech and Religious Liberty.** The Contractor shall ensure that Federal funding is expended in full accordance with the U.S. Constitution, Federal Law, and statutory and public policy requirements: including, but not limited to, those protecting free speech, religious liberty, public welfare, the environment, and prohibiting discrimination.

## **CONTRACT WORK HOURS AND SAFETY STANDARDS ACT**

- a. Applicability: This requirement applies to all FTA grant and cooperative agreement programs.
- b. Where applicable (see 40 U.S.C. § 3701), all contracts awarded by the non-Federal entity in excess of \$100,000 that involve the employment of mechanics or laborers must include a provision for compliance with 40 U.S.C. §§ 3702 and 3704, as supplemented by Department of Labor regulations at 29 C.F.R. Part 5. See 2 C.F.R. Part 200, Appendix II.
- c. Under 40 U.S.C. § 3702, each contractor must be required to compute the wages of every mechanic and laborer on the basis of a standard work week of 40 hours. Work in excess of the standard work week is permissible provided that the worker is compensated at a rate of not less than one and a half times the basic rate of pay for all hours worked in excess of 40 hours in the work week.
- d. The requirements of 40 U.S.C. § 3704 are applicable to construction work and provide that no laborer or mechanic must be required to work in surroundings or under working conditions which are unsanitary, hazardous or dangerous. These requirements do not apply to the purchases of supplies or materials or articles ordinarily available on the open market, or contracts for transportation or transmission of intelligence.
- e. The regulation at 29 C.F.R. § 5.5(b) provides the required contract clause concerning compliance with the Contract Work Hours and Safety Standards Act:

### Compliance with the Contract Work Hours and Safety Standards Act.

- (1) Overtime requirements. No contractor or subcontractor contracting for any part of the contract work which may require or involve the employment of laborers or mechanics shall require or permit any such laborer or mechanic in any workweek in which he or she is employed on such work to work in excess of forty hours in such workweek unless such laborer or mechanic receives compensation at a rate not less than one and one-half times the basic rate of pay for all hours worked in excess of forty hours in such workweek.
- (2) Violation; liability for unpaid wages; liquidated damages. In the event of any violation of the clause set forth in paragraph (1) of this section the contractor and any subcontractor responsible therefor shall be liable for the unpaid wages. In addition, such contractor and subcontractor shall be liable to the United States (in the case of work done under contract for the District of Columbia or a territory, to such District or to such territory), for liquidated damages. Such liquidated damages shall be computed with respect to each individual laborer or mechanic, including watchmen and guards, employed in violation of the clause set forth in paragraph (1) of this section, in the sum of \$10 for each calendar day on which such individual was required or permitted to work in excess of the standard workweek of forty hours without payment of the overtime wages required by the clause set forth in paragraph (1) of this section.
- (3) Withholding for unpaid wages and liquidated damages. The agency shall upon its own action or upon written request of an authorized representative of the Department of Labor withhold or cause to be withheld, from any moneys payable on account of work performed by the contractor or subcontractor under any such contract or any other Federal contract with the same prime contractor, or any other federally-assisted contract subject to the Contract Work Hours and Safety Standards Act, which is held by the same prime contractor, such sums as may be determined to be necessary to satisfy any liabilities of such contractor or subcontractor for unpaid wages and liquidated damages as provided in the clause set forth in paragraph (2) of this section.
- (4) Subcontracts. The contractor or subcontractor shall insert in any subcontracts the clauses set forth in paragraph (1) through (4) of this section and also a clause requiring the subcontractors to include these clauses in any lower tier subcontracts. The prime contractor shall be responsible for compliance by any subcontractor or lower tier subcontractor with the clauses set forth in paragraphs (1) through (4) of this section.”

## **CONFORMANCE WITH ITS NATIONAL ARCHITECTURE**

Intelligent Transportation Systems (ITS) projects shall conform to the National ITS Architecture and standards. Conformance with the National ITS Architecture is interpreted to mean the use of the National ITS Architecture to develop a regional ITS architecture in support of integration and the subsequent adherence of all ITS projects to that regional ITS architecture. Development of the regional ITS architecture should be consistent with the transportation planning process for Statewide and Metropolitan Transportation Planning (49 CFR Part 613 and 621).

## **DEBARMENT AND SUSPENSION**

- a. Applicability: This requirement applies to all FTA grant and cooperative agreement programs for a contract in the amount of at least \$25,000
- (1) This contract is a covered transaction for purposes of 2 C.F.R. pt. 180 and 2 C.F.R. pt. 3000. As such the contractor is required to verify that none of the contractor, its principals (defined at 2 C.F.R. § 180.995), or its affiliates (defined at 2 C.F.R. § 180.905) are excluded (defined at 2 C.F.R. § 180.940) or disqualified (defined at 2 C.F.R. § 180.935).
- (2) C.F.R. pt. 3000, subpart C and must include a requirement to comply with these regulations in any lower tier covered transaction it enters into.
- (3) The accompanying certification is a material representation of fact relied upon by the subrecipient. If it is later determined that the contractor did not comply with 2 C.F.R. pt. 180, subpart C and 2 C.F.R. pt. 3000, subpart C, in addition to remedies available to the Agency and subrecipient, the Federal Government may pursue available remedies, including but not limited to suspension and/or debarment.

The bidder or proposer agrees to comply with the requirements of 2 C.F.R. pt. 180, subpart C and 2 C.F.R. pt. 3000, subpart C while this offer is valid and throughout the period of any contract that may arise from this offer. The bidder or proposer further agrees to include a provision requiring such compliance in its lower tier covered transactions.”

## **DAVIS BACON ACT AND COPELAND ANTI-KICKBACK ACT**

- a. In accordance with the statute, contractors must be required to pay wages to laborers and mechanics at a rate not less than the prevailing wages specified in a wage determination made by the Secretary of Labor. In addition, contractors must be required to pay wages not less than once a week.
- b. The Non-Federal entity must place a copy of the current prevailing wage determination issued by the Department of Labor in each solicitation. The decision to award a contract or subcontract must be conditioned upon the acceptance of the wage determination. The non-Federal entity must report all suspected or reported violations to the Federal awarding agency.

### “Compliance with the Copeland “Anti-Kickback” Act.

- (1) Contractor. The contractor shall comply with 18 U.S.C. § 874, 40 U.S.C. § 3145, and the requirements of 29 C.F.R. pt. 3 as may be applicable, which are

incorporated by reference into this contract.

(2) Subcontracts. The contractor or subcontractor shall insert in any subcontracts the clause above and such other clauses as the FTA may by appropriate instructions require, and also a clause requiring the subcontractors to include these clauses in any lower tier subcontracts. The prime contractor shall be responsible for the compliance by any subcontractor or lower tier subcontractor with all of these contract clauses.

(3) Breach. A breach of the contract clauses above may be grounds for termination of the contract, and for debarment as a contractor and subcontractor as provided in 29 C.F.R. § 5.12.

## **DISADVANTAGED BUSINESS ENTERPRISE (DBE)**

The contractor or subcontractor shall not discriminate on the basis of race, color, national origin, or sex in the performance of this contract. The contractor shall carry out applicable requirements of 49 C.F.R. part 26 in the award and administration of DOT-assisted contracts. Failure by the contractor to carry out these requirements is a material breach of this contract, which may result in the termination of this contract or such other remedy as the Agency deems appropriate, which may include, but is not limited to:

(1) Withholding monthly progress payments; (2) Assessing sanctions; (3) Liquidated damages; and/or (4) Disqualifying the contractor from future bidding as non-responsible. 49 C.F.R. § 26.13(b).

Prime contractors are required to pay subcontractors for satisfactory performance of their contracts no later than 30 days from receipt of each payment the Agency makes to the prime contractor. 49 C.F.R. § 26.29(a).

Finally, for contracts with defined DBE contract goals, each FTA Recipient must include in each prime contract a provision stating that the contractor shall utilize the specific DBEs listed unless the contractor obtains the Agency's written consent; and that, unless the Agency's consent is provided, the contractor shall not be entitled to any payment for work or material unless it is performed or supplied by the listed DBE. 49 C.F.R. § 26.53(f) (1).

It is the policy of the Agency and the United States Department of Transportation ("DOT") that Disadvantaged Business Enterprises ("DBE's"), as defined herein and in the Federal regulations published at 49 C.F.R. part 26, shall have an equal opportunity to participate in DOT-assisted contracts.

## **DHS SEAL, LOGO, AND FLAGS**

The contractor shall not use the DHS seal(s), logos, crests, or reproductions of flags or likenesses of DHS agency officials without specific FTA pre-approval.

## **ENERGY CONSERVATION**

The contractor agrees to comply with mandatory standards and policies relating to energy efficiency, which are contained in the state energy conservation plan issued in compliance with the Energy Policy and Conservation Act.

## **EQUAL EMPLOYMENT OPPORTUNITY**

During the performance of this contract, the contractor agrees as follows:

(1) The contractor will not discriminate against any employee or applicant for employment because of race, color, religion, sex, sexual orientation, gender identity, or national origin. The contractor will take affirmative action to ensure that applicants are employed, and that employees are treated during employment, without regard to their race, color, religion, sex, sexual orientation, gender identity, or national origin. Such action shall include, but not be limited to the following: Employment, upgrading, demotion, or transfer, recruitment or recruitment advertising; layoff or termination; rates of pay or other forms of compensation; and selection for training, including apprenticeship. The contractor agrees to post in conspicuous places, available to employees and applicants for employment, notices to be provided by the contracting officer setting forth the provisions of this nondiscrimination clause.

(2) The contractor will, in all solicitations or advertisements for employees placed by or on behalf of the contractor, state that all qualified applicants will receive consideration for employment without regard to race, color, religion, sex, sexual orientation, gender identity, or national origin.

(3) The contractor will not discharge or in any other manner discriminate against any employee or applicant for employment because such employee or applicant has inquired about, discussed, or disclosed the compensation of the employee or applicant or another employee or applicant. This provision shall not apply to instances in which an employee who has access to the compensation information of other employees or applicants as a part of such employee's essential job functions discloses the compensation of such other employees or applicants to individuals who do not otherwise have access to such information, unless such disclosure is in response to a formal complaint or charge, in furtherance of an investigation, proceeding, hearing, or action, including an investigation conducted by the employer, or is consistent with the contractor's legal duty to furnish information.

(4) The contractor will send to each labor union or representative of workers with which it has a collective bargaining agreement or other contract or understanding, a notice to be provided by the agency contracting officer, advising the labor union or workers' representative of the contractor's commitments under section 202 of Executive Order 11246 of September 24, 1965, and shall post copies of the notice in conspicuous places available to employees and applicants for employment.

(5) The contractor will comply with all provisions of Executive Order 11246 of September 24, 1965, and of the rules, regulations, and relevant orders of the Secretary of Labor.

(6) The contractor will furnish all information and reports required by Executive Order 11246 of September 24, 1965, and by the rules, regulations, and orders of the Secretary of Labor, or pursuant thereto, and will permit access to his books, records, and accounts by the contracting agency and the Secretary of Labor for purposes of investigation to ascertain compliance with such rules, regulations, and orders.

(7) In the event of the contractor's non-compliance with the nondiscrimination clauses of this contract or with any of such rules, regulations, or orders, this contract may be canceled, terminated or suspended in whole or in part and the contractor may be declared ineligible for further Government contracts in accordance with procedures authorized in Executive Order 11246 of September 24, 1965, and such other sanctions may be imposed and remedies invoked as provided in Executive Order 11246 of September 24, 1965, or by rule, regulation, or order of the Secretary of Labor, or as otherwise provided by law.

(8) The contractor will include the provisions of paragraphs (1) through (8) in every subcontract or purchase order unless exempted by rules, regulations, or orders of the Secretary of Labor issued pursuant to section 204 of Executive Order 11246 of September 24, 1965, so that such provisions will be binding upon each subcontractor or vendor. The contractor will take such action with respect to any subcontract or purchase order as may be directed by the

Secretary of Labor as a means of enforcing such provisions including sanctions for noncompliance: Provided, however, that in the event the contractor becomes involved in, or is threatened with, litigation with a subcontractor or vendor as a result of such direction, the contractor may request the United States to enter into such litigation to protect the interests of the United States.

## **FEDERAL CHANGES**

49 CFR Part 18 Federal Changes - Contractor shall at all times comply with all applicable FTA regulations, policies, procedures and directives, including without limitation those listed directly or by reference in the Master Agreement between Purchaser and FTA, as they may be amended or promulgated from time to time during the term of this contract. Contractor's failure to so comply shall constitute a material breach of this contract.

## **FLY AMERICA**

a) Definitions. As used in this clause—

1) "International air transportation" means transportation by air between a place in the United States and a place outside the United States or between two places both of which are outside the United States. 2) "United States" means the 50 States, the District of Columbia, and outlying areas. 3) "U.S.-flag air carrier" means an air carrier holding a certificate under 49 U.S.C. Chapter 411.

b) When Federal funds are used to fund travel, Section 5 of the International Air Transportation Fair Competitive Practices Act of 1974 (49 U.S.C. 40118) (Fly America Act) requires contractors, Agencies, and others use U.S.-flag air carriers for U.S. Government-financed international air transportation of personnel (and their personal effects) or property, to the extent that service by those carriers is available. It requires the Comptroller General of the United States, in the absence of satisfactory proof of the necessity for foreign-flag air transportation, to disallow expenditures from funds, appropriated or otherwise established for the account of the United States, for international air transportation secured aboard a foreign-flag air carrier if a U.S.-flag air carrier is available to provide such services.

c) If available, the Contractor, in performing work under this contract, shall use U.S.-flag carriers for international air transportation of personnel (and their personal effects) or property.

d) In the event that the Contractor selects a carrier other than a U.S.-flag air carrier for international air transportation, the Contractor shall include a statement on vouchers involving such transportation essentially as follows:

### Statement of Unavailability of U.S.-Flag Air Carriers

International air transportation of persons (and their personal effects) or property by U.S.-flag air carrier was not available or it was necessary to use foreign-flag air carrier service for the following reasons. See FAR § 47.403. [State reasons]:

e) Contractor shall include the substance of this clause, including this paragraph (e), in each subcontract or purchase under this contract that may involve international air transportation.

## **INCORPORATION OF FEDERAL TRANSIT ADMINISTRATION (FTA) TERMS**

Incorporation of Federal Transit Administration (FTA) Terms - The provisions within include, in part, certain Standard Terms and Conditions required by DOT, whether or not expressly set forth in the preceding contract provisions. All contractual provisions required by DOT, as set forth in the current FTA Circular 4220 are hereby incorporated by reference. Anything to the contrary herein notwithstanding, all FTA mandated terms shall be deemed to control in the event of a conflict with other provisions contained in this Contract. The Contractor shall not perform any act, fail to perform any act, or refuse to comply with any request which would cause a violation of the FTA terms and conditions.



## **NO GOVERNMENT OBLIGATION TO THIRD PARTIES**

The Agency and Contractor acknowledge and agree that, notwithstanding any concurrence by the Federal Government in or approval of the solicitation or award of the underlying Contract, absent the express written consent by the Federal Government, the Federal Government is not a party to this Contract and shall not be subject to any obligations or liabilities to the Agency, Contractor or any other party (whether or not a party to that contract) pertaining to any matter resulting from the underlying Contract. The Contractor agrees to include the above clause in each subcontract financed in whole or in part with Federal assistance provided by the FTA. It is further agreed that the clause shall not be modified, except to identify the subcontractor who will be subject to its provisions.

## **NOTIFICATION TO FTA**

If a current or prospective legal matter that may affect the Federal Government emerges, the Recipient must promptly notify the FTA Chief Counsel and FTA Regional Counsel for the Region in which the Recipient is located. The Recipient must include a similar notification requirement in its Third Party Agreements and must require each Third Party Participant to include an equivalent provision in its sub agreements at every tier, for any agreement that is a "covered transaction" according to 2 C.F.R. §§ 180.220 and 1200.220.

(1) The types of legal matters that require notification include, but are not limited to, a major dispute, breach, default, litigation, or naming the Federal Government as a party to litigation or a legal disagreement in any forum for any reason.

(2) Matters that may affect the Federal Government include, but are not limited to, the Federal Government's interests in the Award, the accompanying Underlying Agreement, and any Amendments thereto, or the Federal Government's administration or enforcement of federal laws, regulations, and requirements.

(3) The Recipient must promptly notify the U.S. DOT Inspector General in addition to the FTA Chief Counsel or Regional Counsel for the Region in which the Recipient is located, if the Recipient has knowledge of potential fraud, waste, or abuse occurring on a Project receiving assistance from FTA. The notification provision applies if a person has or may have submitted a false claim under the False Claims Act, 31 U.S.C. § 3729 et seq., or has or may have committed a criminal or civil violation of law pertaining to such matters as fraud, conflict of interest, bribery, gratuity, or similar misconduct. This responsibility occurs whether the Project is subject to this Agreement or another agreement between the Recipient and FTA, or an agreement involving a principal, officer, employee, agent, or Third Party Participant of the Recipient. It also applies to subcontractors at any tier. Knowledge, as used in this paragraph, includes, but is not limited to, knowledge of a criminal or civil investigation by a Federal, state, or local law enforcement or other investigative agency, a criminal indictment or civil complaint, or probable cause that could support a criminal indictment, or any other credible information in the possession of the Recipient.

## **PROCUREMENT OF RECOVERED MATERIALS**

(1) In the performance of this contract, the Contractor shall make maximum use of products containing recovered materials that are EPA- designated items unless the product cannot be acquired—

- i. Competitively within a timeframe providing for compliance with the contract performance schedule;
- ii. Meeting contract performance requirements; or
- iii. At a reasonable price.

(2) Information about this requirement, along with the list of EPA-designate items, is available at EPA's Comprehensive Procurement Guidelines web site, <https://www.epa.gov/smm/comprehensive-procurement-guideline-cpg-program>."

## **PROGRAM FRAUD AND FALSE OR FRAUDULENT STATEMENTS AND RELATED ACTS**

The contractor acknowledges that 31 U.S.C. Chap. 38 (Administrative Remedies for False Claims and Statements) applies to the contractor's actions pertaining to this contract."

## **PROHIBITION ON CERTAIN TELECOMMUNICATIONS AND VIDEO SURVEILLANCE SERVICES OR EQUIPMENT.**

a. Recipients and subrecipients are prohibited from obligating or expending loan or grant funds to:

1. Procure or obtain;
2. Extend or renew a contract to procure or obtain;or
3. Enter into a contract (or extend or renew a contract) to procure or obtain equipment, services, or systems that users covered telecommunications equipment or services as a substantial or essential component of any system, or as critical technology as part of any system. As described in Public Law 115-232, section 889, covered telecommunications equipment is telecommunications equipment produced by Huawei Technologies Company or ZTE Corporation (or any subsidiary or affiliate of such entities).
  - i. For the purpose of public safety, security of government facilities, physical security surveillance of critical infrastructure, and other national security purposes, video surveillance and telecommunications equipment produced by Hytera Communications Corporation, Hangzhou Hikvision Digital Technology Company, or Dahua Technology Company(or any subsidiary or affiliate of such entities).
  - ii. Telecommunications or video surveillance services provided by such entities or using such equipment.
  - iii. Telecommunications or video surveillance equipment or services produced or provided by an entity that the Secretary of Defense, in consultation with the Director of the National Intelligence or the Director of the Federal Bureau of Investigation, reasonably believes to be an entity owned or controlled by, or otherwise connected to, the government of a covered foreign country.

b. In implementing the prohibition under Public Law 115-232, section 889, subsection (f),paragraph(1), heads of executive agencies administering loan, grant, or subsidy programs shall prioritize available funding and technical support to assist affected businesses, institutions and organizations as is reasonably necessary for those affected entities to transition from covered communications equipment and services, to procure replacement equipment and services, and to ensure that communications service to users and customers is sustained.

c. See Public Law 115-232,section 889 for additional information.

d. See also \$200.471.

## **PROMPT PAYMENT**

The contractor is required to pay its subcontractors performing work related to this contract for satisfactory performance of that work no later than 30 days after the contractor's receipt of payment for that work. In addition, the contractor is required to return any retainage payments to those subcontractors within 30 days after the subcontractor's work related to this contract is satisfactorily completed.

The contractor must promptly notify the Agency, whenever a DBE subcontractor performing work related to this contract is terminated or fails to complete its work and must make good faith efforts to engage another DBE subcontractor to perform at least the same amount of work. The contractor may not terminate any DBE subcontractor and perform that work through its own forces or those of an affiliate without prior written consent of the Agency.

## **SAFE OPERATION OF MOTOR VEHICLES**

### **Seat Belt Use**

The Contractor is encouraged to adopt and promote on-the-job seat belt use policies and programs for its employees and other personnel that operate company-owned vehicles, company rented vehicles, or personally operated vehicles. The terms "company-owned" and "company-leased" refer to vehicles owned or leased either by the Contractor or Agency.

### **Distracted Driving**

The Contractor agrees to adopt and enforce workplace safety policies to decrease crashes caused by distracted drivers, including policies to ban text messaging while using an electronic device supplied by an employer, and driving a vehicle the driver owns or rents, a vehicle Contractor owns, leases, or rents, or a privately-owned vehicle when on official business in connection with the work performed under this Contract.

## **SEISMIC SAFETY**

The contractor agrees that any new building or addition to an existing building will be designed and constructed in accordance with the standards for Seismic Safety required in Department of Transportation (DOT) Seismic Safety Regulations 49 C.F.R. part 41 and will certify to compliance to the extent required by the regulation. The contractor also agrees to ensure that all work performed under this contract, including work performed by a subcontractor, is in compliance with the standards required by the Seismic Safety regulations and the certification of compliance issued on the project.

## **SPECIAL DOL EEO CLAUSE**

Applies to construction contracts > \$10,000; This contractor and subcontractor shall abide by the requirements of 41 CFR 60-1.4(a), 60-300.5(a) and 60-741.5(a). These regulations prohibit discrimination against qualified individuals based on their status as protected veterans or individuals with disabilities and prohibit discrimination against all individuals based on their race, color, religion, sex, sexual orientation, gender identity or national origin. Moreover, these regulations require that covered prime contractors and subcontractors take affirmative action to employ and advance in employment individuals without regard to race, color, religion, sex, sexual orientation, gender identity, national origin, disability or veteran status.

## **SPECIAL NOTIFICATION REQUIREMENTS FOR STATES**

Applies to States –

a. To the extent required under federal law, the State, as the Recipient, agrees to provide the following information about federal assistance awarded for its State Program, Project, or related activities:

- (1) The Identification of FTA as the federal agency providing the federal assistance for a State Program or Project;
- (2) The Catalog of Federal Domestic Assistance Number of the program from which the federal assistance for a State Program or Project is authorized; and
- (3) The amount of federal assistance FTA has provided for a State Program or Project.

b. Documents - The State agrees to provide the information required under this provision in the following documents: (1) applications for federal assistance, (2) requests for proposals or solicitations, (3) forms, (4) notifications, (5) press releases, and (6) other publications.

## **SIMPLIFIED ACQUISITION THRESHOLD**

Contracts for more than the simplified acquisition threshold, which is the inflation adjusted amount determined by the Civilian Agency Acquisition Council and the Defense Acquisition Regulations Council (Councils) as authorized by 41 U.S.C. § 1908, or otherwise set by law, must address administrative, contractual, or legal remedies in instances where contractors violate or breach contract terms, and provide for such sanctions and penalties as appropriate. (Note that the simplified acquisition threshold determines the procurement procedures that must be employed pursuant to 2 C.F.R. §§ 200.317–200.327. The simplified acquisition threshold does not exempt a procurement from other eligibility or processes requirements that may apply. For example, Buy America's eligibility and process requirements apply to any procurement in excess of \$150,000. 49 U.S.C. § 5323(j)(13).

## **TERMINATION**

### Termination for Convenience (General Provision)

The Agency may terminate this contract, in whole or in part, at any time by written notice to the Contractor when it is in the Agency's best interest. The Contractor shall be paid its costs, including contract close-out costs, and profit on work performed up to the time of termination. The Contractor shall promptly submit its termination claim to Agency to be paid the Contractor. If the Contractor has any property in its possession belonging to Agency, the Contractor will account for the same, and dispose of it in the manner Agency directs.

### Termination for Default [Breach or Cause] (General Provision)

If the Contractor does not deliver supplies in accordance with the contract delivery schedule, or if the contract is for services, the Contractor fails to perform in the manner called for in the contract, or if the Contractor fails to comply with any other provisions of the contract, the Agency may terminate this contract for default. Termination shall be effected by serving a Notice of Termination on the Contractor setting forth the manner in which the Contractor is in default. The Contractor will be paid only the contract price for supplies delivered and accepted, or services performed in accordance with the manner of performance set forth in the contract. If it is later determined by the Agency that the Contractor had an excusable reason for not performing, such as a strike, fire, or flood, events which are not the fault of or are beyond the control of the Contractor, the Agency, after setting up a new delivery of performance

schedule, may allow the Contractor to continue work, or treat the termination as a Termination for Convenience.

#### Opportunity to Cure (General Provision)

The Agency, in its sole discretion may, in the case of a termination for breach or default, allow the Contractor [an appropriately short period of time] in which to cure the defect. In such case, the Notice of Termination will state the time period in which cure is permitted and other appropriate conditions

If Contractor fails to remedy to Agency's satisfaction the breach or default of any of the terms, covenants, or conditions of this Contract within [10 days] after receipt by Contractor of written notice from Agency setting forth the nature of said breach or default, Agency shall have the right to terminate the contract without any further obligation to Contractor. Any such termination for default shall not in any way operate to preclude Agency from also pursuing all available remedies against Contractor and its sureties for said breach or default.

#### Waiver of Remedies for any Breach

In the event that Agency elects to waive its remedies for any breach by Contractor of any covenant, term or condition of this contract, such waiver by Agency shall not limit Agency's remedies for any succeeding breach of that or of any other covenant, term, or condition of this contract.

#### Termination for Convenience (Professional or Transit Service Contracts)

The Agency, by written notice, may terminate this contract, in whole or in part, when it is in the Agency's interest. If this contract is terminated, the Agency shall be liable only for payment under the payment provisions of this contract for services rendered before the effective date of termination.

#### Termination for Default (Supplies and Service)

If the Contractor fails to deliver supplies or to perform the services within the time specified in this contract or any extension, or if the Contractor fails to comply with any other provisions of this contract, the Agency may terminate this contract for default. The Agency shall terminate by delivering to the Contractor a Notice of Termination specifying the nature of the default. The Contractor will only be paid the contract price for supplies delivered and accepted, or services performed in accordance with the manner or performance set forth in this contract. If, after termination for failure to fulfill contract obligations, it is determined that the Contractor was not in default, the rights and obligations of the parties shall be the same as if the termination had been issued for the convenience of the Agency.

#### Termination for Default (Transportation Services)

If the Contractor fails to pick up the commodities or to perform the services, including delivery services, within the time specified in this contract or any extension, or if the Contractor fails to comply with any other provisions of this contract, the Agency may terminate this contract for default. The Agency shall terminate by delivering to the Contractor a Notice of Termination specifying the nature of default. The Contractor will only be paid the contract price for services performed in accordance with the manner of performance set forth in this contract.

If this contract is terminated while the Contractor has possession of Agency goods, the Contractor shall, upon direction of the Agency, protect and preserve the goods until surrendered to the Agency or its agent. The Contractor and Agency shall agree on payment for the preservation and protection of goods. Failure to agree on an amount will be resolved under the Dispute clause.

If, after termination for failure to fulfill contract obligations, it is determined that the Contractor was not in default, the rights and obligations of the parties shall be the same as if the termination had been issued for the convenience of the Agency.

#### Termination for Default (Construction)

If the Contractor refuses or fails to prosecute the work or any separable part, with the diligence that will ensure its completion within the time specified in this contract or any extension or fails to complete the work within this time, or if the Contractor fails to comply with any other provision of this contract, Agency may terminate this contract for default. The Agency shall terminate by delivering to the Contractor a Notice of Termination specifying the nature of the default. In this event, the Agency may take over the work and compete it by contract or otherwise, and may take possession of and use any materials, appliances, and plant on the work site necessary for completing the work. The Contractor and its sureties shall be liable for any damage to the Agency resulting from the Contractor's refusal or failure to complete the work within specified time, whether or not the Contractor's right to proceed with the work is terminated. This liability includes any increased costs incurred by the Agency in completing the work.

The Contractor's right to proceed shall not be terminated nor shall the Contractor be charged with damages under this clause if: 1. The delay in completing the work arises from unforeseeable causes beyond the control and without the fault or negligence of the Contractor. Examples of such causes include: acts of God, acts of Agency, acts of another contractor in the performance of a contract with Agency, epidemics, quarantine restrictions, strikes, freight embargoes; and 2. The Contractor, within [10] days from the beginning of any delay, notifies Agency in writing of the causes of delay. If, in the judgment of Agency, the delay is excusable, the time for completing the work shall be extended. The judgment of Agency shall be final and conclusive for the parties, but subject to appeal under the Disputes clause(s) of this contract. 3. If, after termination of the Contractor's right to proceed, it is determined that the Contractor was not in default, or that the delay was excusable, the rights and obligations of the parties will be the same as if the termination had been issued for the convenience of Agency.

#### Termination for Convenience or Default (Architect and Engineering)

The Agency may terminate this contract in whole or in part, for the Agency's convenience or because of the failure of the Contractor to fulfill the contract obligations. The Agency shall terminate by delivering to the Contractor a Notice of Termination specifying the nature, extent, and effective date of the termination. Upon receipt of the notice, the Contractor shall (1) immediately discontinue all services affected (unless the notice directs otherwise), and (2) deliver to the Agency's Contracting Officer all data, drawings, specifications, reports, estimates, summaries, and other information and materials accumulated in performing this contract, whether completed or in process. Agency has a royalty-free, nonexclusive, and irrevocable license to reproduce, publish or otherwise use, all such data, drawings, specifications, reports, estimates, summaries, and other information and materials.

If the termination is for the convenience of the Agency, the Agency's Contracting Officer shall make an equitable adjustment in the contract price but shall allow no anticipated profit on unperformed services. If the termination is for failure of the Contractor to fulfill the contract obligations, the Agency may complete the work by contract or otherwise and the Contractor shall be liable for any additional cost incurred by the Agency. If, after termination for failure to fulfill contract obligations, it is determined that the Contractor was not in default, the rights and obligations of the parties shall be the same as if the termination had been issued for the convenience of Agency

#### Termination for Convenience or Default (Cost-Type Contracts)

The Agency may terminate this contract, or any portion of it, by serving a Notice of Termination on the Contractor. The notice shall state whether the termination is for convenience of Agency or for the default of the Contractor. If the termination is for default, the notice shall state the manner in which the Contractor has failed to perform the requirements of the contract. The Contractor shall account for any property in its possession paid for from funds received from the Agency, or property supplied to the Contractor by the Agency. If the termination is for default, the Agency may fix the fee, if the contract provides for a fee, to be paid the Contractor in proportion to the value, if any, of work performed up to the time of termination. The Contractor shall promptly submit its termination claim to the Agency and the parties shall negotiate the termination settlement to be paid the Contractor.

If the termination is for the convenience of Agency, the Contractor shall be paid its contract close-out costs, and a fee, if the contract provided for payment of

a fee, in proportion to the work performed up to the time of termination.

If, after serving a Notice of Termination for Default, the Agency determines that the Contractor has an excusable reason for not performing, the Agency, after setting up a new work schedule, may allow the Contractor to continue work, or treat the termination as a Termination for Convenience.

## **VETERANS HIRING PREFERENCE**

Veterans Employment - Recipients of Federal financial assistance shall ensure that contractors working on a capital project funded using such assistance give a hiring preference, to the extent practicable, to veterans (as defined in section 2108 of title 5) who have the requisite skills and abilities to perform the construction work required under the contract. This subsection shall not be understood, construed or enforced in any manner that would require an employer to give a preference to any veteran over any equally qualified applicant who is a member of any racial or ethnic minority, female, an individual with a disability, or a former employee.

## **VIOLATION AND BREACH OF CONTRACT**

### Rights and Remedies of the Agency

The Agency shall have the following rights in the event that the Agency deems the Contractor guilty of a breach of any term under the Contract.

1. The right to take over and complete the work or any part thereof as agency for and at the expense of the Contractor, either directly or through other contractors; 2. The right to cancel this Contract as to any or all of the work yet to be performed; 3. The right to specific performance, an injunction or any other appropriate equitable remedy; and 4. The right to money damages.

For purposes of this Contract, breach shall include.

### Rights and Remedies of Contractor

Inasmuch as the Contractor can be adequately compensated by money damages for any breach of this Contract, which may be committed by the Agency, the Contractor expressly agrees that no default, act or omission of the Agency shall constitute a material breach of this Contract, entitling Contractor to cancel or rescind the Contract (unless the Agency directs Contractor to do so) or to suspend or abandon performance.

### Remedies

Substantial failure of the Contractor to complete the Project in accordance with the terms of this Contract will be a default of this Contract. In the event of a default, the Agency will have all remedies in law and equity, including the right to specific performance, without further assistance, and the rights to termination or suspension as provided herein. The Contractor recognizes that in the event of a breach of this Contract by the Contractor before the Agency takes action contemplated herein, the Agency will provide the Contractor with sixty (60) days written notice that the Agency considers that such a breach has occurred and will provide the Contractor a reasonable period of time to respond and to take necessary corrective action.

### Disputes

Disputes arising in the performance of this Contract that are not resolved by agreement of the parties shall be decided in writing by an authorized representative of Agency. This decision shall be final and conclusive unless within [10] days from the date of receipt of its copy, the Contractor mails or otherwise furnishes a written appeal to the Agency's authorized representative. In connection with any such appeal, the Contractor shall be afforded an opportunity to be heard and to offer evidence in support of its position. The decision of the Agency's authorized representative shall be binding upon the Contractor and the Contractor shall abide by the decision.

In the event that a resolution of the dispute is not mutually agreed upon, the parties can agree to mediate the dispute or proceed with litigation. Notwithstanding any provision of this section, or any other provision of this Contract, it is expressly agreed and understood that any court proceeding arising out of a dispute under the Contract shall be heard by a Court de novo and the court shall not be limited in such proceeding to the issue of whether the Authority acted in an arbitrary, capricious or grossly erroneous manner.

Pending final settlement of any dispute, the parties shall proceed diligently with the performance of the Contract, and in accordance with the Agency's direction or decisions made thereof.

### Performance during Dispute

Unless otherwise directed by Agency, Contractor shall continue performance under this Contract while matters in dispute are being resolved.

### Claims for Damages

Should either party to the Contract suffer injury or damage to person or property because of any act or omission of the party or of any of its employees, agents or others for whose acts it is legally liable, a claim for damages therefor shall be made in writing to such other party within a reasonable time after the first observance of such injury or damage.

### Remedies

Unless this Contract provides otherwise, all claims, counterclaims, disputes and other matters in question between the Agency and the Contractor arising out of or relating to this Contract or its breach will be decided by arbitration if the parties mutually agree, or in a court of competent jurisdiction within the State in which the Agency is located.

### Rights and Remedies

The duties and obligations imposed by the Contract documents and the rights and remedies available thereunder shall be in addition to and not a limitation of any duties, obligations, rights and remedies otherwise imposed or available by law. No action or failure to act by the Agency or Contractor shall constitute a waiver of any right or duty afforded any of them under the Contract, nor shall any such action or failure to act constitute an approval of or acquiescence in any breach thereunder, except as may be specifically agreed in writing.

**Federal Certifications**

**CERTIFICATION AND RESTRICTIONS ON LOBBYING**

I, \_\_\_\_\_ hereby certify  
(Name and title of official)

On behalf of \_\_\_\_\_ that:  
(Name of Bidder/Company Name)

- No federal appropriated funds have been paid or will be paid, by or on behalf of the undersigned, to any person for influencing or attempting to influence an officer or employee of any agency, a Member of Congress, and officer or employee of Congress, or an employee of a Member of Congress in connection with the awarding of any federal contract, the making of any federal grant, the making of any federal loan, the entering into of any cooperative agreement, and the extension, continuation, renewal, amendment, or modification of any federal contract, grant, loan, or cooperative agreement.
- If any funds other than federal appropriated funds have been paid or will be paid to any person influencing or attempting to influence an officer or employee of any agency, a Member of Congress, and officer or employee of Congress, or an employee of a Member of Congress in connection with the federal contract, grant, loan, or cooperative agreement, the undersigned shall complete and submit Standard Form – LLL, “Disclosure Form to Report Lobbying,” in accordance with its instructions.
- The undersigned shall require that the language of this certification be included in the award documents for all sub-awards at all tiers (including sub-contracts, sub-grants and contracts under grants, loans, and cooperative agreements) and that all sub-recipients shall certify and disclose accordingly.

This certification is a material representation of fact upon which reliance was placed when this transaction was made or entered into. Submission of this certification is a prerequisite for making or entering into this transaction imposed by 31 U.S.C. § 1352 (as amended by the Lobbying Disclosure Act of 1995). Any person who fails to file the required certification shall be subject to a civil penalty of not less than \$10,000 and not more than \$100,000 for each such failure.

The undersigned certifies or affirms the truthfulness and accuracy of the contents of the statements submitted on or with this certification and understands that the provisions of 31 U.S.C. Section 3801, et seq., are applicable thereto.

Name of Bidder/Company Name: \_\_\_\_\_

Type or print name: \_\_\_\_\_

Signature of authorized representative: \_\_\_\_\_ Date \_\_\_\_/\_\_\_\_/\_\_\_\_

Signature of notary and SEAL: \_\_\_\_\_

**GOVERNMENT-WIDE DEBARMENT AND SUSPENSION  
(NONPROCUREMENT)**

---

**Instructions for Certification:** By signing and submitting this bid or proposal, the prospective lower tier participant is providing the signed certification set out below.

(1) It will comply and facilitate compliance with U.S. DOT regulations, "Nonprocurement Suspension and Debarment," 2 CFR part 1200, which adopts and supplements the U.S. Office of Management and Budget (U.S. OMB) "Guidelines to Agencies on Governmentwide Debarment and Suspension (Nonprocurement)," 2 CFR part 180,

(2) To the best of its knowledge and belief, that its Principals and Subrecipients at the first tier:

- a. Are eligible to participate in covered transactions of any Federal department or agency and are not presently:
  - 1. Debarred,
  - 2. Suspended,
  - 3. Proposed for debarment,
  - 4. Declared ineligible,
  - 5. Voluntarily excluded, or
  - 6. Disqualified,
- b. Its management has not within a three-year period preceding its latest application or proposal been convicted of or had a civil judgment rendered against any of them for:
  - 1. Commission of fraud or a criminal offense in connection with obtaining, attempting to obtain, or performing a public (Federal, State, or local) transaction, or contract under a public transaction,
  - 2. Violation of any Federal or State antitrust statute, or,
  - 3. Commission of embezzlement, theft, forgery, bribery, falsification or destruction of records, making any false statement, or receiving stolen property,
- c. It is not presently indicted for, or otherwise criminally or civilly charged by a governmental entity (Federal, State, or local) with commission of any of the offenses listed in the preceding subsection 2.b of this Certification,
- d. It has not had one or more public transactions (Federal, State, or local) terminated for cause or default within a three-year period preceding this Certification,
- e. If, at a later time, it receives any information that contradicts the statements of subsections 2.a – 2.d above, it will promptly provide that information to FTA,
- f. It will treat each lower tier contract or lower tier subcontract under its Project as a covered lower tier contract for purposes of 2 CFR part 1200 and 2 CFR part 180 if it:
  - 1. Equals or exceeds \$25,000,,
  - 2. Is for audit services, or,
  - 3. Requires the consent of a Federal official, and
- g. It will require that each covered lower tier contractor and subcontractor:
  - 1. Comply and facilitate compliance with the Federal requirements of 2 CFR parts 180 and 1200, and
  - 2. Assure that each lower tier participant in its Project is not presently declared by any Federal department or agency to be:
    - a. Debarred from participation in its federally funded Project,
    - b. Suspended from participation in its federally funded Project,
    - c. Proposed for debarment from participation in its federally funded Project,
    - d. Declared ineligible to participate in its federally funded Project,
    - e. Voluntarily excluded from participation in its federally funded Project, or
    - f. Disqualified from participation in its federally funded Project, and
  - 3. It will provide a written explanation as indicated on a page attached in FTA's TrAMS platform or the Signature Page if it or any of its principals, including any of its first tier Subrecipients or its Third-Party Participants at a lower tier, is unable to certify compliance with the preceding statements in this Certification Group.

(3) It will provide a written explanation as indicated on a page attached in FTA's TrAMS platform or the Signature Page if it or any of its principals, including any of its first tier Subrecipients or its Third-Party Participants at a lower tier, is unable to certify compliance with the preceding statements in this Certification Group.

**Certification**

Contractor: \_\_\_\_\_

Signature of Authorized Official: \_\_\_\_\_ Date \_\_\_\_\_ / \_\_\_\_\_ / \_\_\_\_\_

Name and Title of Contractor's Authorized Official: \_\_\_\_\_

**BUY AMERICA CERTIFICATION  
STEEL OR MANUFACTURED PRODUCTS**

---

General Requirement (as stated in 49 CFR 661.5)

- a. Except as provided in 49 CFR 661.7 and 49 CFR 661.11, no funds may be obligated by FTA for a grantee project unless all iron, steel, and manufactured products used in the project are produced in the United States.
- b. All steel and iron manufacturing processes must take place in the United States, except metallurgical processes involving refinement of steel additives.
- c. The steel and iron requirements apply to all construction materials made primarily of steel or iron and used in infrastructure projects such as, transit or maintenance facilities, rail lines, and bridges. These items include, but are not limited to, structural steel or iron, steel or iron beams and columns, running rail and contact rail. These requirements do not apply to steel or iron used as components or subcomponents of other manufactured products or rolling stock, or to bimetallic power rail incorporating steel or iron components.
- d. For a manufactured product to be considered produced in the United States:
  - 1. All of the manufacturing processes for the product must take place in the United States; and
  - 2. All of the components of the product must be of U.S. origin. A component is considered of U.S. origin if it is manufactured in the United States, regardless of the origin of its subcomponents.

If steel, iron, or manufactured products (as defined in 49 CFR 661.3 and 661.5) are being procured, the appropriate certificate as set forth below shall be completed and submitted by each bidder or offeror in accordance with the requirement contained in 49 CFR 661.13(b).

**Certificate of Compliance with Buy America Requirements**

The bidder or offeror hereby certifies that it will comply with the requirements of 49 U.S.C. 5323(j)(1), and the applicable regulations in 49 CFR part 661.

Company \_\_\_\_\_  
Name \_\_\_\_\_ Title \_\_\_\_\_  
Signature \_\_\_\_\_ Date \_\_\_\_\_

**Certificate of Non-Compliance with Buy America Steel or Manufactured Products Requirements**

The bidder or offeror hereby certifies that it cannot comply with the requirements of 49 U.S.C. 5323(j), but it may qualify for an exception to the requirement pursuant to 49 U.S.C. 5323(j)(2), as amended, and the applicable regulations in 49 C.F.R. 661.7.

Company \_\_\_\_\_  
Name \_\_\_\_\_ Title \_\_\_\_\_  
Signature \_\_\_\_\_ Date \_\_\_\_\_

# ATTACHMENT K

## Davis-Bacon Wage Determination

§ 24 of the Federal Transit Administration Master Agreement delineates TTA's obligations to comply with the employee protection requirements of the Davis-Bacon Act. For construction activities exceeding \$2,000 performed in connection with an FTA-funded Project, TTA agrees to comply with, and assure compliance with, the requirements of 49 U.S.C. §5333(a), the Davis-Bacon Act, and the implementing regulations of the Department of Labor at 29 CFR Part 5.

The Davis-Bacon Act (the Act) provides that contracts in excess of \$2,000 to which the United States is a party (i.e., federal funds are involved) for construction, alteration, or repair (including painting and decorating) of public buildings or public works within the United States shall contain a clause that no laborer or mechanic employed directly upon the site of the work shall receive less than the prevailing wage rates as determined by the Secretary of Labor. That rate of pay is referred to as the "Davis-Bacon wage rate" and is specifically identified in this Exhibit E.

The contractor shall submit weekly for each week in which any contract work is performed a copy of all payrolls to the Triangle Transit for transmission to the Federal Transit Administration. The payrolls submitted shall set out accurately and completely all of the information required to be maintained under section 5.5(a)(3)(i) of Regulations, 29 CFR part 5. This information may be submitted in any form desired.

Each payroll submitted shall be accompanied by a "Statement of Compliance," signed by the contractor or subcontractor or his or her agent who pays or supervises the payment of the persons employed under the contract and shall certify the following:

- (1) That the payroll for the payroll period contains the information required to be maintained under section 5.5(a)(3)(i) of Regulations, 29 CFR part 5 and that such information is correct and complete;
- (2) That each laborer or mechanic (including each helper, apprentice, and trainee) employed on the contract during the payroll period has been paid the full weekly wages earned, without rebate, either directly or indirectly, and that no deductions have been made either directly or indirectly from the full wages earned, other than permissible deductions as set forth in Regulations, 29 CFR part 3;
- (3) That each laborer or mechanic has been paid not less than the applicable wage rates and fringe benefits or cash equivalents for the classification of work performed, as specified in the applicable wage determination incorporated into the contract.

General Decision Number: NC140040 01/03/2014 NC40

Superseded General Decision Number: NC20130040

State: North Carolina

Construction Type: Building

County: Wake County in North Carolina.

BUILDING CONSTRUCTION PROJECTS (does not include single family homes or apartments up to and including 4 stories).

Modification Number	Publication Date
0	01/03/2014

*Davis Bacon Wage Rates*



CARP1263-005 07/01/2011

	Rates	Fringes
MILLWRIGHT.....	\$ 23.32	8.69

---

IRON0848-005 12/01/2012

	Rates	Fringes
IRONWORKER, STRUCTURAL.....	\$ 21.80	9.75

---

\* PLUM0421-003 07/01/2013

	Rates	Fringes
PIPEFITTER.....	\$ 24.85	9.65

---

SUNC2011-021 08/24/2011

	Rates	Fringes
BRICKLAYER.....	\$ 19.00	0.00
CARPENTER (Drywall Hanging Only).....	\$ 13.83	0.00
CARPENTER, Excludes Drywall Hanging, and Form Work.....	\$ 17.55	4.14
CEMENT MASON/CONCRETE FINISHER...\$	14.19	0.00
ELECTRICIAN.....	\$ 18.48	3.18
FORM WORKER.....	\$ 12.43	1.80
LABORER: Common or General.....\$	9.73	0.00
LABORER: Landscape & Irrigation.....\$	9.13	0.28
LABORER: Pipelayer.....	\$ 13.35	2.80
LABORER: Mason Tender-Brick/Cement/Concrete.....\$	12.00	0.00
OPERATOR: Backhoe/Excavator/Trackhoe.....\$	15.64	2.22
OPERATOR: Bulldozer.....	\$ 16.00	1.87
OPERATOR: Crane.....	\$ 19.77	4.48
OPERATOR: Forklift.....	\$ 13.86	0.00

OPERATOR: Grader/Blade.....	\$ 15.72	1.49
OPERATOR: Loader.....	\$ 16.17	0.25
Painter: Brush, Roller and Spray.....	\$ 12.35	0.00
PLUMBER.....	\$ 19.35	2.43
ROOFER.....	\$ 11.06	1.26
SHEET METAL WORKER (HVAC Duct Installation Only).....	\$ 20.86	2.25
SHEET METAL WORKER, Excludes HVAC Duct Installation.....	\$ 15.81	1.40

-----

WELDERS - Receive rate prescribed for craft performing operation to which welding is incidental.

=====

Unlisted classifications needed for work not included within the scope of the classifications listed may be added after award only as provided in the labor standards contract clauses (29CFR 5.5 (a) (1) (ii)).

-----

The body of each wage determination lists the classification and wage rates that have been found to be prevailing for the cited type(s) of construction in the area covered by the wage determination. The classifications are listed in alphabetical order of "identifiers" that indicate whether the particular rate is union or non-union.

Union Identifiers

An identifier enclosed in dotted lines beginning with characters other than "SU" denotes that the union classification and rate have found to be prevailing for that classification. Example: PLUM0198-005 07/01/2011. The first four letters , PLUM, indicate the international union and the four-digit number, 0198, that follows indicates the local union number or district council number where applicable , i.e., Plumbers Local 0198. The next number, 005 in the example, is an internal number used in processing the wage determination. The date, 07/01/2011, following these characters is the effective date of the most current negotiated rate/collective bargaining agreement which would be July 1, 2011 in the above example.

Union prevailing wage rates will be updated to reflect any changes in the collective bargaining agreements governing the rates.

0000/9999: weighted union wage rates will be published annually each January.

#### Non-Union Identifiers

Classifications listed under an "SU" identifier were derived from survey data by computing average rates and are not union rates; however, the data used in computing these rates may include both union and non-union data. Example: SULA2004-007 5/13/2010. SU indicates the rates are not union majority rates, LA indicates the State of Louisiana; 2004 is the year of the survey; and 007 is an internal number used in producing the wage determination. A 1993 or later date, 5/13/2010, indicates the classifications and rates under that identifier were issued as a General Wage Determination on that date.

Survey wage rates will remain in effect and will not change until a new survey is conducted.

---

#### WAGE DETERMINATION APPEALS PROCESS

1.) Has there been an initial decision in the matter? This can be:

- \* an existing published wage determination
- \* a survey underlying a wage determination
- \* a Wage and Hour Division letter setting forth a position on a wage determination matter
- \* a conformance (additional classification and rate) ruling

On survey related matters, initial contact, including requests for summaries of surveys, should be with the Wage and Hour Regional Office for the area in which the survey was conducted because those Regional Offices have responsibility for the Davis-Bacon survey program. If the response from this initial contact is not satisfactory, then the process described in 2.) and 3.) should be followed.

With regard to any other matter not yet ripe for the formal process described here, initial contact should be with the Branch of Construction Wage Determinations. Write to:

Branch of Construction Wage Determinations  
Wage and Hour Division  
U.S. Department of Labor  
200 Constitution Avenue, N.W.

Washington, DC 20210

2.) If the answer to the question in 1.) is yes, then an interested party (those affected by the action) can request review and reconsideration from the Wage and Hour Administrator (See 29 CFR Part 1.8 and 29 CFR Part 7). Write to:

Wage and Hour Administrator  
U.S. Department of Labor  
200 Constitution Avenue, N.W.  
Washington, DC 20210

The request should be accompanied by a full statement of the interested party's position and by any information (wage payment data, project description, area practice material, etc.) that the requestor considers relevant to the issue.

3.) If the decision of the Administrator is not favorable, an interested party may appeal directly to the Administrative Review Board (formerly the Wage Appeals Board). Write to:

Administrative Review Board  
U.S. Department of Labor  
200 Constitution Avenue, N.W.  
Washington, DC 20210

4.) All decisions by the Administrative Review Board are final.

=====

END OF GENERAL DECISION

## ATTACHMENT-L

### **GUIDE TO M/WBE REQUIRED FORMS**

All GoTriangle's procurements have a section entitled "**MINORITY AND WOMEN OWNED BUSINESS ENTERPRISE REQUIREMENTS.**" This section of procurement sets forth the established GoTriangle's goal for this particular procurement and also describes the forms that must be completed with their proposal. Below is a summary of the forms used in the GoTriangle M/WBE Participation Program by a Consultant.

**Form #1: Consultant M/WBE Utilization Plan** - This document must be completed by all Consultants responding to RFPs with an M/WBE goal greater than zero. The Consultant must demonstrate how it plans to meet the stated M/WBE goal. In completing this form, the Consultant should describe the steps taken to establish communication with M/WBE firms and identify current or future relationships with certified M/WBE firms. The second page of the form should list the M/WBE certified firms that the vendor plans to engage with on the project and the amount that each certified firm is projected to be paid. Plans to work with uncertified firms do not meet the criteria for participation. If the plan is not submitted or is deemed deficient, the Consultant may be sent a notice of deficiency. It is mandatory that all awards with goals have a utilization plan on file.

**Form #2: M/WBE Utilization Waiver Request** - This document must be filled out by the Consultant if the utilization plan (Form #1) indicates less than the stated participation goal for the procurement. In this instance, Form #2 must accompany Form #1 with the proposal. When completing Form #2, it is important that the Consultant thoroughly document the steps that were taken to meet the goal and provide evidence in the form of attachments to the document. The required attachments are listed on Form #2 and will document the good-faith efforts taken to meet the desired goal. A Consultant can also attach additional evidence outside of those referenced attachments. Without evidence of good-faith efforts, in the form of attachments or other documentation, GoTriangle may not approve the waiver and the Consultant may be deemed non-responsive.

New M/WBE firms are being certified daily and new M/WBE firms may now be available to provide products or services that were historically unavailable. If Form #2 is found by GoTriangle to be deficient, the Consultant will be sent a deficiency letter and may be deemed non-responsive.

Any questions regarding completion of these forms can be sent to [procurement@gotriangle.org](mailto:procurement@gotriangle.org)

**M/WBE Form #1  
CONSULTANT M/WBE UTILIZATION PLAN**

<b>Consultant Name:</b>	
<b>Vendor ID:</b>	<b>Telephone No.</b>
<b>RFP/Contract Title:</b>	<b>RFP/Contract No.</b>

**Description of Plan to Meet M/WBE Goals (Use pages 3-4 to provide specific MBE and WBE subcontractor information)**

---



---



---



---



---



---



---



---



---



---

**PROJECTED M/WBE USAGE IN PERCENTAGE**

	%
<b>1. MBE Goal Applied to Eligible Costs</b>	
<b>2. WBE Goal Applied to Eligible Costs</b>	
<b>3. M/WBE Combined Totals*</b>	

\*If less than the stated goal in RFP, Form #2 is required.

**CONSULTANT PROPOSED MBE UTILIZATION PLAN  
MINORITY OWNED BUSINESS ENTERPRISE (MBE) INFORMATION**

**In order to achieve the MBE 15.48 % Goal, Consultant expects to subcontract with North Carolina Department of Transportation certified MINORITY-OWNED entities as follows:  
(add additional pages as needed)**

<b>MBE Firm (Exactly as Registered)</b>	<b>Description of Work (Products/Services) [MBE]</b>	<b>Projected MBE Percentage</b>
<b>Name</b>  <b>Address</b>  <b>City, State, ZIP</b>  <b>Employer I.D.</b>  <b>Telephone Number</b> ( ) -		_____
<b>Name</b>  <b>Address</b>  <b>City, State, ZIP</b>  <b>Employer I.D.</b>  <b>Telephone Number</b> ( ) -		_____
<b>Name</b>  <b>Address</b>  <b>City, State, ZIP</b>  <b>Employer I.D.</b>  <b>Telephone Number</b> ( ) -		_____

**CONSULTANT PROPOSED WBE UTILIZATION PLAN  
WOMEN OWNED BUSINESS ENTERPRISE (WBE) INFORMATION**

**In order to achieve the WBE Goal of     %, Consultant expects to subcontract with North Carolina Department of Transportation certified WOMEN-OWNED entities as follows:  
(add additional pages as needed)**

<b>WBE Firm (Exactly as Registered)</b>	<b>Description of Work (Products/Services) [WBE]</b>	<b>Projected WBE Percentage</b>
<b>Name</b> <b>Address</b> <b>City, State, ZIP</b> <b>Employer I.D.</b> <b>Telephone Number</b> ( ) -		<b>\$</b> _____
<b>Name</b> <b>Address</b> <b>City, State, ZIP</b> <b>Employer I.D.</b> <b>Telephone Number</b> ( ) -		<b>\$</b> _____
<b>Name</b> <b>Address</b> <b>City, State, ZIP</b> <b>Employer I.D.</b> <b>Telephone Number</b> ( ) -		<b>\$</b> _____



## M/WBE Form #2

### M/WBE UTILIZATION WAIVER REQUEST

<b>Consultant Name :</b>	<b>DATE:</b>		
<b>Address:</b>	<b>RFP No.:</b>		
<b>City, State, Zip Code:</b>	<b>M/WBE Goals: MBE____% WBE ____%</b> (From Lines 1&2 of Form 1)		
<b>By submitting this form and the required information, the officer or/consultant certifies that every Good Faith Effort has been taken to promote M/WBE participation pursuant to the M/WBE requirements set forth under this solicitation.</b>			
<b>Consultant is requesting a :</b>			
<input type="checkbox"/> <b>MBE Waiver – A waiver of the MBE Goal for this procurement is requested. Total <input type="checkbox"/> / Partial <input type="checkbox"/> check one</b> <input type="checkbox"/> <b>WBE Waiver – A waiver of the WBE Goal for this procurement is requested. Total <input type="checkbox"/> / Partial <input type="checkbox"/> check one</b> <input type="checkbox"/> <b>Waiver Pending Certification – (Check here if subcontractors or suppliers of Consultant are not certified M/WBE, but an application for certification has been filed.)</b> <b>Date of such filing:</b>			
<u>If a total or partial waiver is requested, appropriate supporting documentation of Good Faith Efforts shall be provided as instructed on page 6.</u>			
<hr/> <table style="width: 100%; border: none;"> <tr> <td style="width: 50%;"><b>PREPARED BY (Signature)</b></td> <td style="width: 50%;"><b>Date:</b></td> </tr> </table> <p>By signing and submitting this form, the contractor certifies that a good faith effort has been made to promote M/WBE participation pursuant to the M/WBE requirements set forth under this solicitation. Failure to submit complete and accurate information may result in a finding of noncompliance and deemed non-responsive.</p>		<b>PREPARED BY (Signature)</b>	<b>Date:</b>
<b>PREPARED BY (Signature)</b>	<b>Date:</b>		
<b>Name and Title of Preparer (Printed or Typed):</b>	<b>Telephone Number:</b>		
<b>Email Address:</b>			
<b>Submit with the bid or proposal</b>	<b>*****FOR GOTRIANGLE USE ONLY *****</b>		
	<table style="width: 100%; border: none;"> <tr> <td style="width: 70%;"><b>REVIEWED BY:</b></td> <td style="width: 30%;"><b>DATE:</b></td> </tr> </table>	<b>REVIEWED BY:</b>	<b>DATE:</b>
	<b>REVIEWED BY:</b>	<b>DATE:</b>	
<b>Waiver Granted: <input type="checkbox"/> YES <input type="checkbox"/> NO</b> <b>MBE: <input type="checkbox"/> WBE: <input type="checkbox"/></b> <input type="checkbox"/> <b>Total Waiver</b> <input type="checkbox"/> <b>Partial Waiver</b> <input type="checkbox"/> <b>Certification Waiver</b> <input type="checkbox"/> <b>Notice of Deficiency Issued</b> _____			

**Explanation why Consultant is unable to meet M/WBE goals for this project:**

---

---

---

---

---

---

---

**Include attachments below to evidence good faith efforts:**

- Attachment A. List of the general circulation, trade and M/WBE-oriented publications and dates of publications soliciting for certified M/WBE participation as a subcontractor/supplier and copies of such solicitation.
- Attachment B. List of the certified M/WBEs appearing in the NCDOT M/WBE directory that were solicited for this contract. Provide proof of dates or copies of the solicitations and copies of the responses made by the certified M/WBEs. Describe specific reasons that responding certified M/WBEs were not selected.
- Attachment C. Descriptions of the contract documents/plans/specifications made available to certified M/WBEs by the contractor when soliciting their participation and steps taken to structure the scope of work for the purpose of subcontracting with or obtaining supplies from certified M/WBEs.
- Attachment D. Description of the negotiations between the contractor and certified M/WBEs for the purposes of complying with the M/WBE goals of this contract.
- Attachment E. Identify dates of any pre-proposal, pre-award or other meetings attended by consultant.
- Attachment F. Other information deemed relevant to the request.

**THIS DOCUMENT MUST BE SUBMITTED WITH EACH PAY REQUEST AND  
FINAL PAYMENT  
MBE/WBE DOCUMENTATION FOR CONTRACT  
PAYMENTS**

Prime Consultant: \_\_\_\_\_  
 Address & Phone Number: \_\_\_\_\_  
 Project Name: \_\_\_\_\_  
 Pay Application Number: \_\_\_\_\_ Period: \_\_\_\_\_

The following is a list of payments to be made to minority business sub-consultants on this project for the above-mentioned period.

Minority Firm Name and Address	Minority Category MBE/WBE*	Amount Paid For This Period	Amount Paid To Date
_____	_____	_____	_____
_____	_____	_____	_____
_____	_____	_____	_____
_____	_____	_____	_____
_____	_____	_____	_____
_____	_____	_____	_____
_____	_____	_____	_____
_____	_____	_____	_____
_____	_____	_____	_____
_____	_____	_____	_____

\*Minority Categories: Black, African American (B), Hispanic (H), Asian American (AA), American Indian (AI), Female (WF), Socially and Economically Disadvantaged (SE), and Disabled (D).

Total MBE % for this Period: \_\_\_\_\_ Total WBE % for this Period: \_\_\_\_\_

**ATTACHMENT- K**

**RFP RESPONSE CHECKLIST**

---

## Table of Contents

1.0 Vendor Response Checklist .....	2
2.0 Vendor Attachments.....	3

---

## 1.0 Proposer Response Checklist

**ALL FORMS AND REQUIRED INFORMATION BELOW MUST BE COMPLETED AND INCLUDED WHEN YOU SUBMIT YOUR PROPOSAL PACKAGE:**

**Table 1 Vendor Response Checklist**

<b>Item #</b>	<b>Proposal Response Item</b>	<b>Completed and Provided as Instructed</b>	
<b>1</b>	A. Cover Sheet	<b>YES</b> <input type="checkbox"/>	<b>NO</b> <input type="checkbox"/>
<b>2</b>	B. Table of Contents	<b>YES</b> <input type="checkbox"/>	<b>NO</b> <input type="checkbox"/>
<b>3</b>	C. Concise Letter of Interest	<b>YES</b> <input type="checkbox"/>	<b>NO</b> <input type="checkbox"/>
<b>4</b>	D. Statement of Judgments	<b>YES</b> <input type="checkbox"/>	<b>NO</b> <input type="checkbox"/>
<b>5</b>	E. Understanding of Scope of Work	<b>YES</b> <input type="checkbox"/>	<b>NO</b> <input type="checkbox"/>
<b>6</b>	F. Qualifications and Experience	<b>YES</b> <input type="checkbox"/>	<b>NO</b> <input type="checkbox"/>
<b>7</b>	G. Previous Experience of Similar Scope of Work	<b>YES</b> <input type="checkbox"/>	<b>NO</b> <input type="checkbox"/>
<b>8</b>	H. References from Previous Clients	<b>YES</b> <input type="checkbox"/>	<b>NO</b> <input type="checkbox"/>
<b>9</b>	I. Start-Up and Transition Plan	<b>YES</b> <input type="checkbox"/>	<b>NO</b> <input type="checkbox"/>
<b>10</b>	J. Attachments	<b>YES</b> <input type="checkbox"/>	<b>NO</b> <input type="checkbox"/>

## 2.0 Proposer Attachments

The Proposer must complete the following table identifying all the other documents that are being attached as part of the RFP response.

**Table 2 Vendor Attachment Checklist**

Item #	Attachment Name	Attachment Provided?	
		YES <input type="checkbox"/>	NO <input type="checkbox"/>
1	A. Proposal Submittal Form (Attachment A)	YES <input type="checkbox"/>	NO <input type="checkbox"/>
2	B. Bid Form (Attachment B)	YES <input type="checkbox"/>	NO <input type="checkbox"/>
3	C. Minimum Insurance Requirements (Attachment C)	YES <input type="checkbox"/>	NO <input type="checkbox"/>
4	D. E-Verify Form (Attachment D)	YES <input type="checkbox"/>	NO <input type="checkbox"/>
5	E. Contractor's Statement of Sales/Use Tax (Attachment E)	YES <input type="checkbox"/>	NO <input type="checkbox"/>
6	F. Iran Divestment Act Form (Attachment F)	YES <input type="checkbox"/>	NO <input type="checkbox"/>
7	G. Companies Boycotting Israel Divestment Act Form (Attachment G)	YES <input type="checkbox"/>	NO <input type="checkbox"/>
8	H. Certificate Regarding Conflict of Interest (Attachment H)	YES <input type="checkbox"/>	NO <input type="checkbox"/>
9	I. Non - Collusion (Attachment I)	YES <input type="checkbox"/>	NO <input type="checkbox"/>
10	J. W/WBE Forms (Attachment J)	YES <input type="checkbox"/>	NO <input type="checkbox"/>
11	K. Davis-Bacon Rate Forms (Attachment K)	YES <input type="checkbox"/>	NO <input type="checkbox"/>
11	L. Federal Clauses	YES <input type="checkbox"/>	NO <input type="checkbox"/>
11	M. RFP Response	YES <input type="checkbox"/>	NO <input type="checkbox"/>

# Exhibit A



## GoTRIANGLE BUS STOP IMPROVEMENTS CONSTRUCTION GROUP K

**SITES 620, 701, 804, 808,  
936, 937, 956**

**SPECIAL CONDITIONS OF APPROVAL:**

- PER UDO SECTION 6.12.2.H.2, A PEDESTRIAN TRAFFIC CONTROL PLAN IS REQUIRED FOR ANY PEDESTRIAN PATH WHICH WILL BE INACCESSIBLE FOR MORE THAN 7 DAYS. AN ADDITIONAL SHEET ILLUSTRATING THE PEDESTRIAN TRAFFIC CONTROL PLANS MUST BE PROVIDED FOR REVIEW/APPROVAL THROUGH CONSTRUCTION DRAWING REVIEW PROCESS.
- DEVELOPMENT PURSUANT TO THIS SITE PLAN/CONSTRUCTION DRAWING RELIES IN PART ON GOTRIANGLE ACQUIRING INTERESTS IN PROPERTY IN THE NAME OF THE CITY FOR USE AS RIGHT OF WAY. THE ACQUIRED RIGHT OF WAY SHALL BE USED FOR THE CONSTRUCTION AND MAINTENANCE OF THE BUS STOP. GOTRIANGLE SHALL CONSTRUCT THE BUS STOP IN COMPLIANCE WITH ALL APPLICABLE CITY REQUIREMENTS. VESTED RIGHTS ARE NOT CREATED IN ANY COMPONENT OF THIS SITE PLAN/CONSTRUCTION DRAWING TO THE EXTENT THAT GOTRIANGLE FAILS TO ACQUIRE THE NECESSARY PROPERTY INTERESTS FOR THE CITY AS STATED HEREIN.

**PUBLIC WORKS CONDITION OF APPROVAL:**

- THE DESIGNING PROFESSIONAL (A NCPE, NCPLS, OR NCRLA - AS REQUIRED) SHALL SUBMIT THREE (3) SETS OF CONSTRUCTION DRAWINGS TO THE PUBLIC WORKS DEPARTMENT - DEVELOPMENT REVIEW FOR REVIEW AND APPROVAL. CONSTRUCTION DRAWING APPROVAL IS REQUIRED PRIOR TO COMMENCING CONSTRUCTION (SEE CONSTRUCTION PLAN APPROVAL PROCESS). THE APPROVAL OF CONSTRUCTION DRAWINGS IS SEPARATE FROM SITE PLAN APPROVAL. CITY OFFICIALS SHALL REVIEW ALL SIZES, MATERIALS, SLOPES, LOCATIONS, EXTENSIONS AND DEPTHS FOR ALL PROPOSED UTILITIES (WATERLINES, SANITARY SEWER LINES AND STORM DRAINAGE CONVEYANCE SYSTEMS) FOR COMPLIANCE WITH ALL APPLICABLE REGULATORY STANDARDS, SPECIFICATIONS, AND BEST MANAGEMENT PRACTICES.
- THE DESIGNING PROFESSIONAL (A NCPE, NCPLS, OR NCRLA - AS REQUIRED) SHALL SUBMIT ONE (1) SET OF AS-BUILT DRAWINGS TO THE PUBLIC WORKS DEPARTMENT - DEVELOPMENT REVIEW FOR REVIEW AND APPROVAL. AS-BUILT DRAWING APPROVAL IS REQUIRED PRIOR TO WATER METER INSTALLATION AND/OR SANITARY SEWER SERVICE CONNECTION AND PRIOR TO ISSUANCE OF A CERTIFICATE OF OCCUPANCY.
- A CONSTRUCTION ON CITY RIGHT-OF-WAY/PRIVATE PROPERTY PERMIT MAY BE REQUIRED. CONTACT THE PUBLIC WORKS CUSTOMER SERVICE DESK AT 560-4326.

DOCUMENT NOT CONSIDERED FINAL UNLESS ALL SIGNATURES COMPLETED



DRMP INC.  
1000 FAIRMOUNT PLACE  
RALEIGH, NC 27608  
PHONE 919-272-0115  
www.drmpinc.com License No. 041524

BENJAMIN R. LENNON, PE  
PROJECT ENGINEER  
ERIC H. ALSPAUGH  
PROJECT DESIGN ENGINEER

DESIGN ENGINEER









CITY OF DURHAM  
GODURHAM BUS STOPS  
CITY OF DURHAM  
STANDARD DETAILS

REVISIONS	DATE	BY	DESCRIPTION

DATE: 04/08/2024  
 CHECKED BY: EHA  
 CHECKED BY: BRK

NOT TO SCALE



**DRMP**  
 DRMP ENGINEERING, PLLC  
 5000 HARRINGTON PLACE  
 RALEIGH, NC 27609  
 (919) 875-5113  
 www.drmp.com

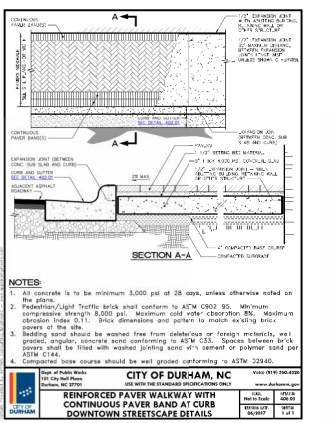
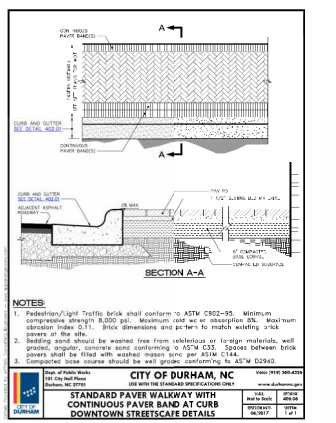
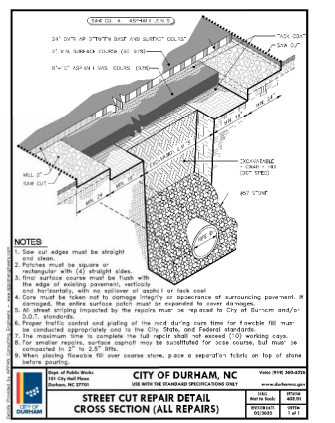
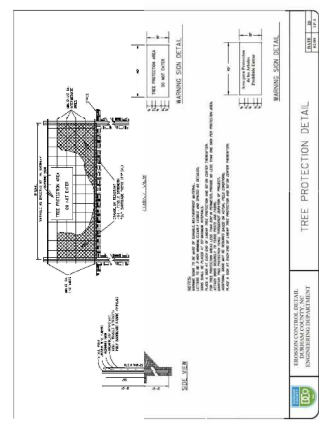
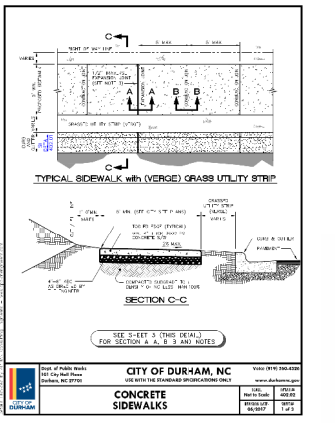
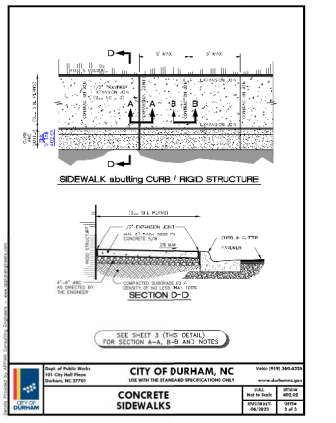
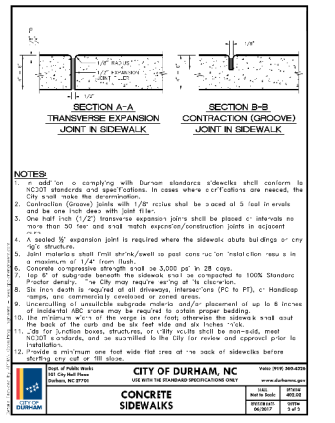
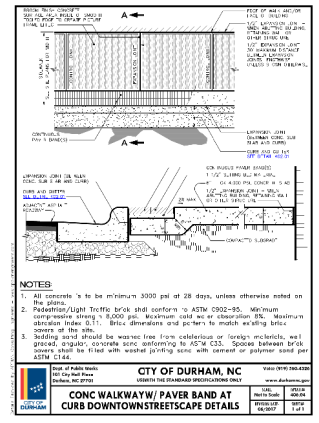

4/8/2024  
 City of Durham, Group K, Decatur, N.C.



CITY OF DURHAM  
GODURHAM BUS STOPS  
CITY OF RALEIGH  
STANDARD DETAILS

NO.	DATE	DESCRIPTION

DATE: 04/08/2024  
CREATED BY: EHA  
CHECKED BY: BRL

NOT TO SCALE

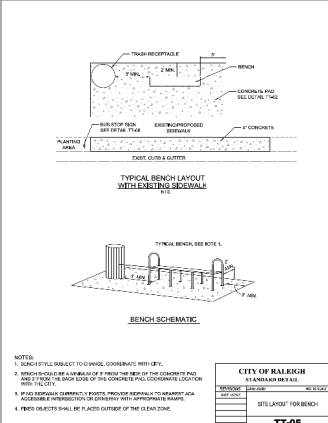
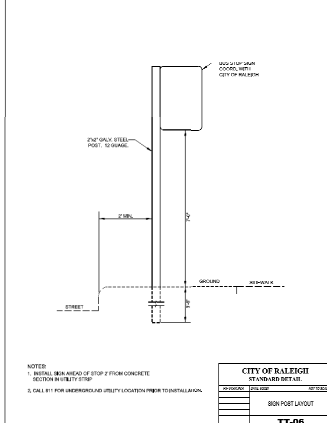
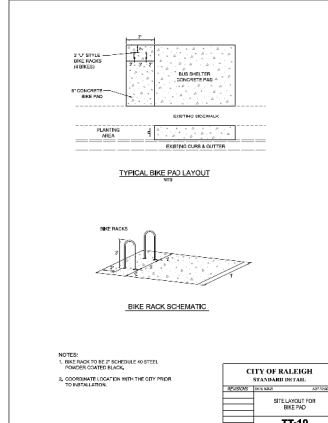
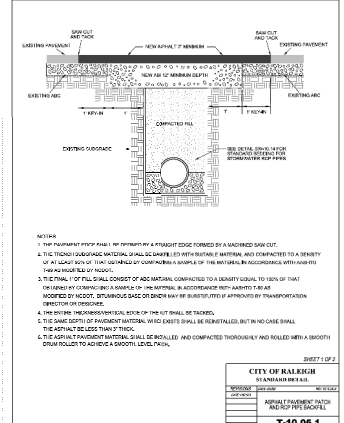
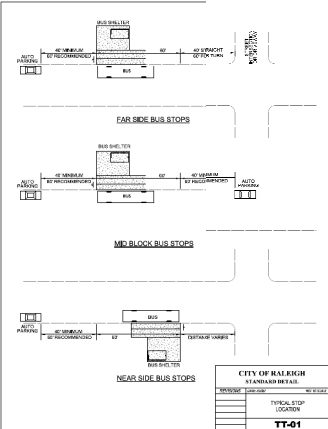
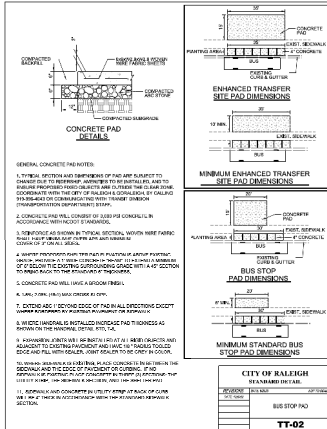
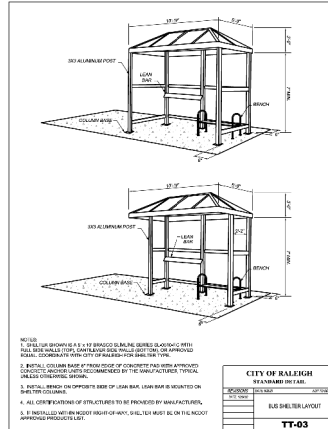
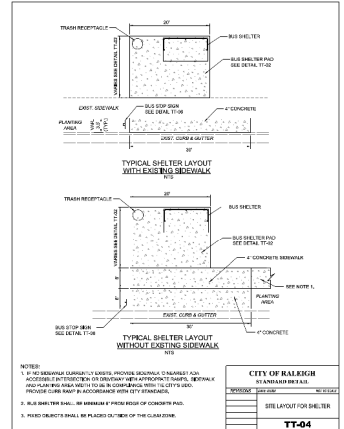

4/8/2024  
City of Durham Group K Design



CITY OF DURHAM  
GODURHAM BUS STOPS  
CITY OF RALEIGH  
STANDARD DETAILS

NO.	DATE	DESCRIPTION

DATE: 04/08/2024  
 CREATED BY: EHA  
 CHECKED BY: BRL

NOT TO SCALE

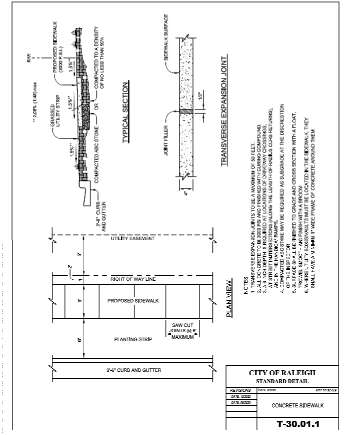

CITY OF RALEIGH  
STANDARD DETAIL  
CONCRETE RETAINING WALL  
T-30.01.1

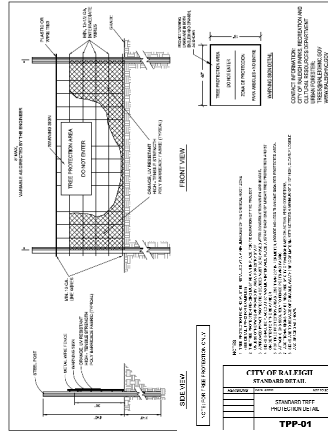

CITY OF RALEIGH  
STANDARD DETAIL  
STORMWATER INLET  
SW-20.01

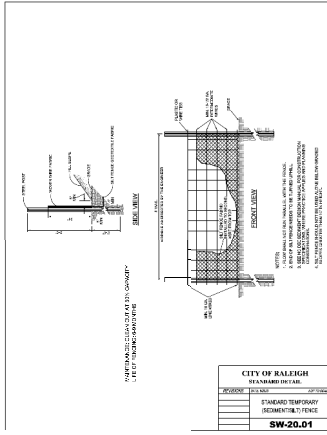

CITY OF RALEIGH  
STANDARD DETAIL  
ASPHALT PAVEMENT PATCH  
T-10.05.2

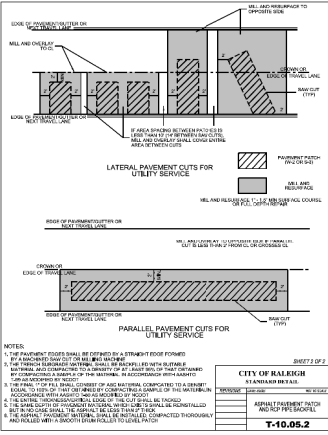

CITY OF RALEIGH  
STANDARD DETAIL  
LATERAL AND PARALLEL PAVEMENT CUTS FOR UTILITY SERVICE  
T-10.05.2

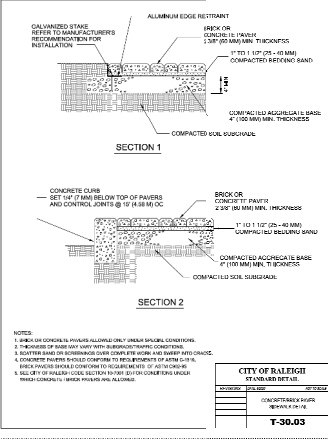

CITY OF RALEIGH  
STANDARD DETAIL  
CONCRETE SLAB  
T-30.03

4/8/2024  
 City of Durham, Triangle, Durham Group, K. Deaton, EHA



NO.	DATE	DESCRIPTION

DATE: 04/08/2024  
 CREATED BY: EHA  
 CHECKED BY: BRL

NOT TO SCALE



- NOTES
- BUS SHELTER DESIGN AND DIMENSIONS ARE PROVIDED BY THE MANUFACTURER. THE CONTRACTOR SHALL VERIFY DIMENSIONS AND QUANTITIES WITH THE SHELTER MANUFACTURER AND SHALL ACCORDING TO THE MANUFACTURER'S SPECIFICATIONS AND MFG. REQUIREMENTS.
  - ALL SHELTERS, BENCHES, BIKESHARE STATIONS, TRASH CANS AND OTHER AMENITIES ARE TO BE INSTALLED BY THE CONTRACTOR UNLESS OTHERWISE NOTED. SEE GENERAL NOTES ON SHEET 2A.
  - SHELTER COLUMN BASES ARE TO BE INSTALLED A MINIMUM OF 6" FROM EDGE OF CONCRETE UNLESS OTHERWISE NOTED.
  - UNLESS OTHERWISE SHOWN, SHELTERS TO BE USED IN THE CITY OF DURHAM ARE TO BE BLACK, SLOTTED POLYCARBONATE SHELTERS WITH POLYCARBONATE WALLS WITH FULL BACK AND HALF END WALLS OF 3/4" THICK AND CLEAR POLYCARBONATE AND WHITE ALUMINUM FINISH COLOR.
  - UNLESS OTHERWISE SHOWN, SHELTERS TO BE USED IN THE CITY OF RALEIGH ARE TO BE 16' TALL CANOPY SHELTERS.
  - UNLESS OTHERWISE SHOWN, SHELTERS TO BE USED IN ORANGE COUNTY ARE TO BE 9' TALL CANOPY SHELTERS.

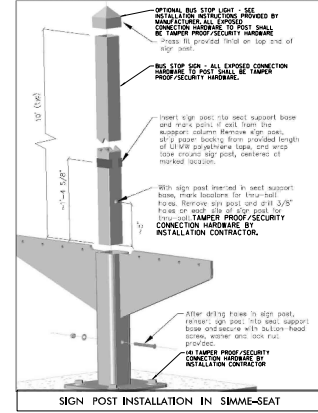
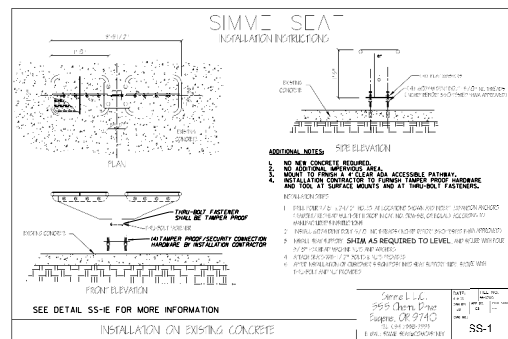
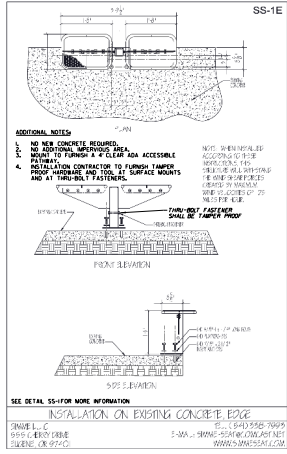
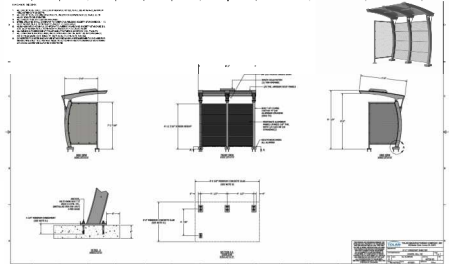
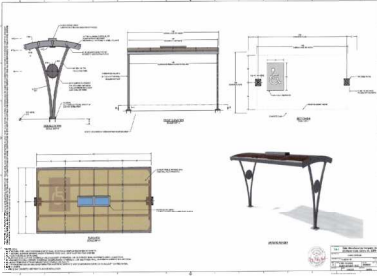
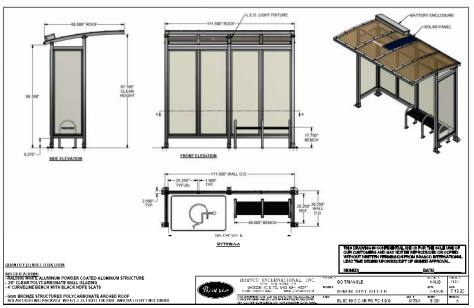

4/8/2024 10:00 AM CST Triangle Group, K. Deaton, jdg

**NOTES:**

- 1) ALL S/L MEMBERS COATED BY ZINC RICH EPLOY THEN FINISHED BY POWDERED FINISH COATING
- 2) 1/2" x 3/4" x 3/4" EXPANSION ANCHOR BOLTS PROVIDED
- 3) EXTERN SETTING ANCHORS FOR RECEIVED HOLES PROVIDED (1 PER SPACER)
- 4) EXTERN SETTING (17 SPACERS)

**LEGEND:**

- E BENCH
- F BENCH

**ITEM:** BENCH  
**SCALE:** 1/4" = 1'-0"  
**DATE:** 04/15/2024  
**BY:** J. D. [Signature]  
**APP:** [Signature]

**NOTES:**

- 1) ASSEMBLY INSTRUCTIONS
- 2) EXPANSION ANCHOR BOLTS PROVIDED
- 3) EXTERN SETTING ANCHORS FOR RECEIVED HOLES PROVIDED (1 PER SPACER)
- 4) EXTERN SETTING (17 SPACERS)

**ITEM:** BENCH  
**SCALE:** 1/4" = 1'-0"  
**DATE:** 04/15/2024  
**BY:** J. D. [Signature]  
**APP:** [Signature]

**NOTES:**

- 1) BENCH SEATING FINISHED BY ZINC RICH EPLOY THEN FINISHED BY POWDERED FINISH COATING
- 2) 1/2" x 3/4" x 3/4" EXPANSION ANCHOR BOLTS PROVIDED
- 3) EXTERN SETTING ANCHORS FOR RECEIVED HOLES PROVIDED (1 PER SPACER)
- 4) EXTERN SETTING (17 SPACERS)

**ITEM:** BENCH  
**SCALE:** 1/4" = 1'-0"  
**DATE:** 04/15/2024  
**BY:** J. D. [Signature]  
**APP:** [Signature]

**NOTES:**

- 1) BENCH SEATING FINISHED BY ZINC RICH EPLOY THEN FINISHED BY POWDERED FINISH COATING
- 2) 1/2" x 3/4" x 3/4" EXPANSION ANCHOR BOLTS PROVIDED
- 3) EXTERN SETTING ANCHORS FOR RECEIVED HOLES PROVIDED (1 PER SPACER)
- 4) EXTERN SETTING (17 SPACERS)

**ITEM:** BENCH  
**SCALE:** 1/4" = 1'-0"  
**DATE:** 04/15/2024  
**BY:** J. D. [Signature]  
**APP:** [Signature]

**NOTES:**

- 1) ALL S/L MEMBERS COATED BY ZINC RICH EPLOY THEN FINISHED BY POWDERED FINISH COATING
- 2) 1/2" x 3/4" x 3/4" EXPANSION ANCHOR BOLTS PROVIDED
- 3) EXTERN SETTING ANCHORS FOR RECEIVED HOLES PROVIDED (1 PER SPACER)
- 4) EXTERN SETTING (17 SPACERS)

**ITEM:** BENCH  
**SCALE:** 1/4" = 1'-0"  
**DATE:** 04/15/2024  
**BY:** J. D. [Signature]  
**APP:** [Signature]

**NOTES:**

- 1) ASSEMBLY INSTRUCTIONS
- 2) EXPANSION ANCHOR BOLTS PROVIDED
- 3) EXTERN SETTING ANCHORS FOR RECEIVED HOLES PROVIDED (1 PER SPACER)
- 4) EXTERN SETTING (17 SPACERS)

**ITEM:** BENCH  
**SCALE:** 1/4" = 1'-0"  
**DATE:** 04/15/2024  
**BY:** J. D. [Signature]  
**APP:** [Signature]

**NOTES:**

- 1) BENCH SEATING FINISHED BY ZINC RICH EPLOY THEN FINISHED BY POWDERED FINISH COATING
- 2) 1/2" x 3/4" x 3/4" EXPANSION ANCHOR BOLTS PROVIDED
- 3) EXTERN SETTING ANCHORS FOR RECEIVED HOLES PROVIDED (1 PER SPACER)
- 4) EXTERN SETTING (17 SPACERS)

**ITEM:** BENCH  
**SCALE:** 1/4" = 1'-0"  
**DATE:** 04/15/2024  
**BY:** J. D. [Signature]  
**APP:** [Signature]

**NOTES:**

- 1) BENCH SEATING FINISHED BY ZINC RICH EPLOY THEN FINISHED BY POWDERED FINISH COATING
- 2) 1/2" x 3/4" x 3/4" EXPANSION ANCHOR BOLTS PROVIDED
- 3) EXTERN SETTING ANCHORS FOR RECEIVED HOLES PROVIDED (1 PER SPACER)
- 4) EXTERN SETTING (17 SPACERS)

**ITEM:** BENCH  
**SCALE:** 1/4" = 1'-0"  
**DATE:** 04/15/2024  
**BY:** J. D. [Signature]  
**APP:** [Signature]



CITY OF DURHAM  
GODURHAM BUS STOPS  
BUS STOP AMENITY DETAILS

NO.	DATE	DESCRIPTION

DATE: 04/05/2024  
DRAWN BY: EHA  
CHECKED BY: BRL

NOT TO SCALE



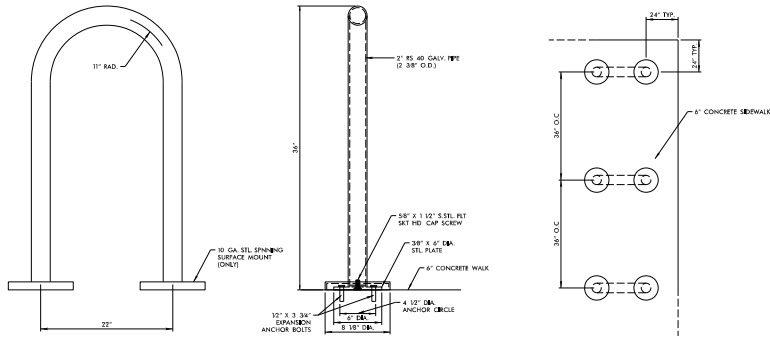

BIKE RACK DETAILS

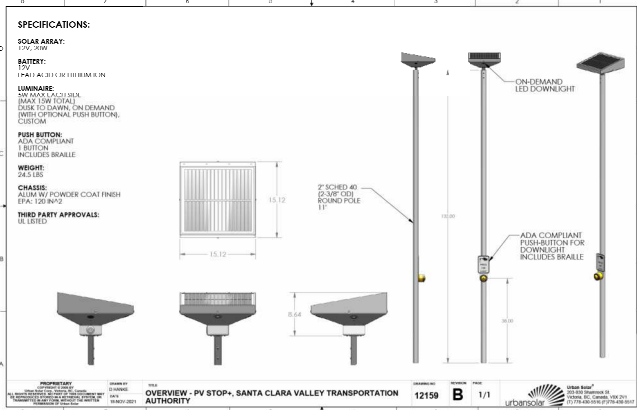
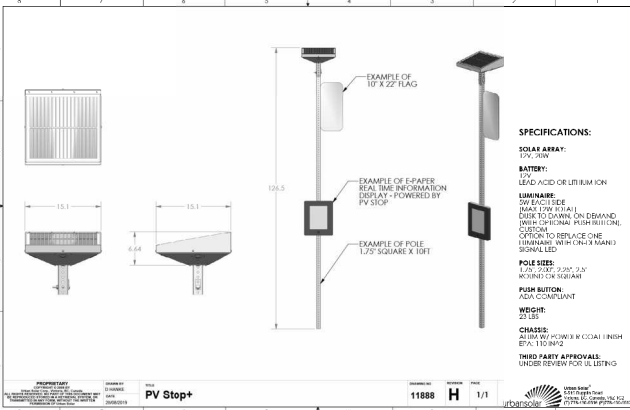

NOT TO SCALE  
\*2" SQUARE POST SIZE TO BE USED UNLESS OTHERWISE NOTED  
FOR ALL SOLAR LIGHTING SYSTEM  
AND PUSH-BUTTON ASSEMBLIES.

REVISIONS

NO.	DATE	DESCRIPTION

DATE: 04/26/2024  
DRAWN BY: EHA  
CHECKED BY: BRL

NOT TO SCALE

DRMP

DRMP ENGINEERING & ARCHITECTURE  
1000 HARRINGTON PLACE  
RALEIGH, NC 27609  
(919) 875-5113  
www.drmp.com

NO LICENSE N.C. 14-124

4/26/2024  
CST:trnglb, vcb:trnglb, k:Deaton,ldjg



CITY OF DURHAM  
GODURHAM BUS STOPS  
CURB RAMP DETAILS

REVISIONS

NO.	DATE	DESCRIPTION

DATE: 04/08/2024  
 CREATED BY: EHA  
 CHECKED BY: BRL

NOT TO SCALE



DRMP  
 5000 HARRINGTON PLACE  
 RALEIGH, NC 27609  
 (919) 875-5113  
 NC LICENSE NO. 1-124  
 www.drmp.com

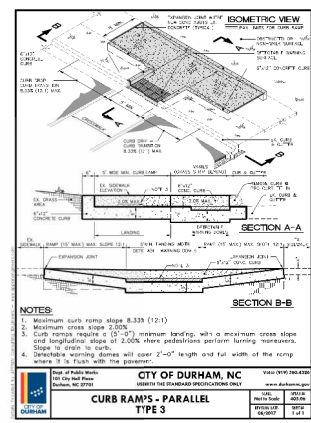
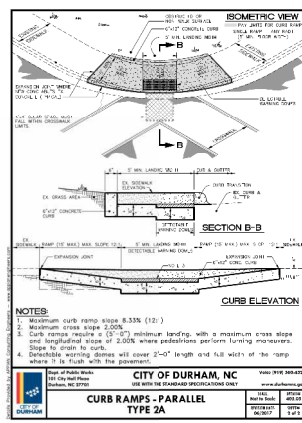
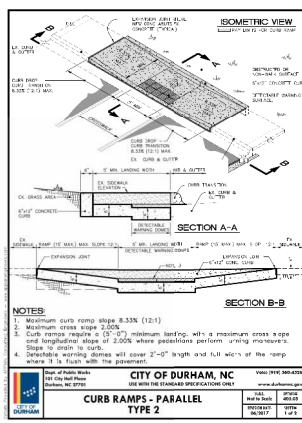
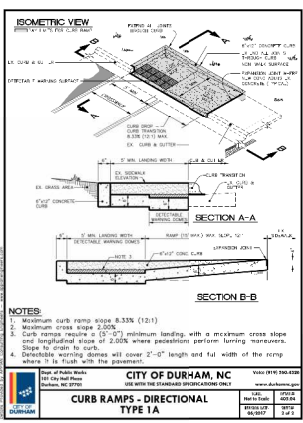
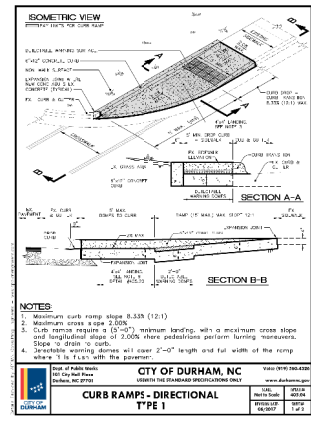
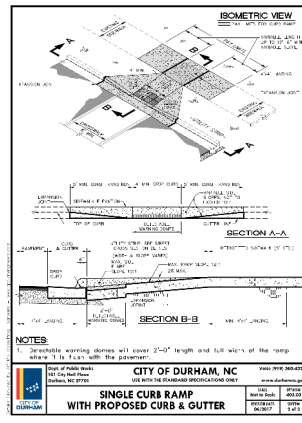
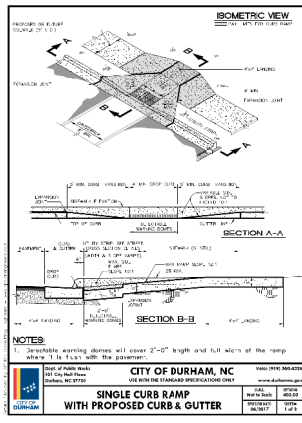
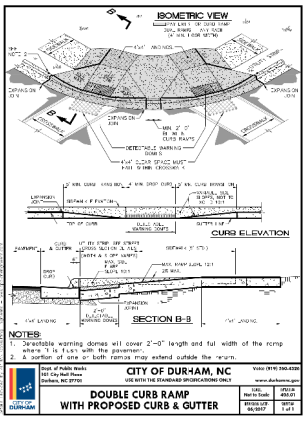







CITY OF DURHAM  
GODURHAM BUS STOPS  
CURB RAMP DETAILS

NO.	DATE	DESCRIPTION

DATE: 04/05/2024  
 CREATED BY: EHA  
 CHECKED BY: BRL

NOT TO SCALE



**DRMP**  
 5000 FAIRGROVE PLACE  
 RALEIGH, NC 27609  
 (919) 875-5113  
 NC LICENSE NO. 14-1284  
 www.drmp.com

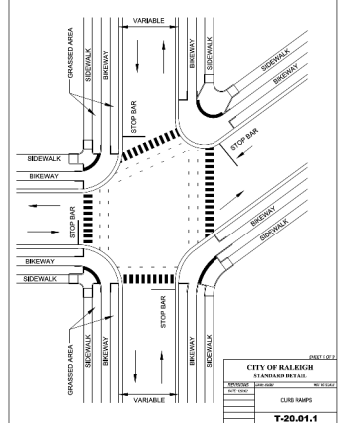
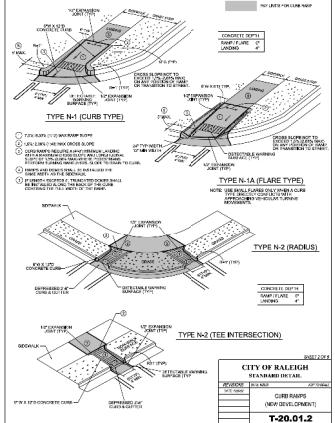
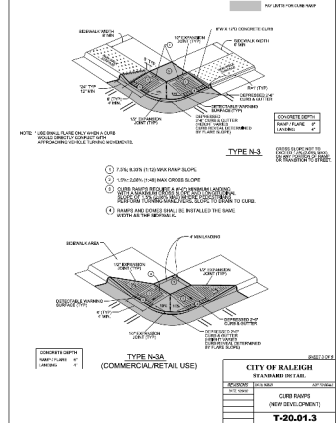
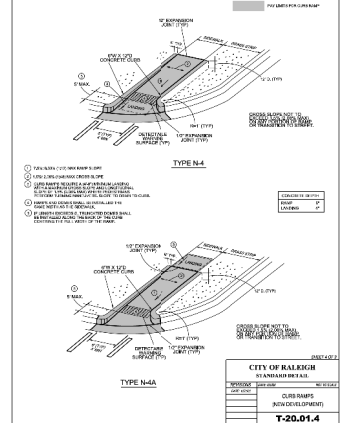

**CITY OF RALEIGH CURB RAMPS GENERAL NOTES**

- CITY OF RALEIGH (STANDARD CURB) RAMPS HAVE BEEN DEVELOPED IN ACCORDANCE WITH THE AMERICANS WITH DISABILITIES ACT (ADA) AND PUBLIC RIGHT-OF-WAY ACCESS GUIDELINES (PROVING).
- CURB RAMPS SHALL BE PROVIDED AT LOCATIONS AS SHOWN ON THE PLAN OR AS DIRECTED BY THE ENGINEER. SPECIAL ACCESS RAMPS SHALL BE LOCATED AS INDICATED IN THE PLAN. HOWEVER, THE LOCATION MAY BE ADJUSTED IN COORDINATION WITH THE CITY OF RALEIGH STREET LIGHTING DEPARTMENT, STREET LIGHTS, STOP SIGNS, ETC. AFFECT PLACEMENT.
- DOUBLE (W) FET (C) RAMPS ARE TO BE INSTALLED AT ALL PUBLIC STREET INTERSECTIONS WITH A 15' SIDEWALK WIDTH MINIMUM.
- THE WALKING SURFACE SHALL BE SLIP RESISTANT. THE COLOR FOR THE DETECTABLE WARNING AREA SHALL BE YELLOW FOR CONTRAST.
- NO IS OFF ON THE SIDEWALK ACCESS RAMPS SHALL EXCEED 11 FT (15) IN RATIO RELATIONSHIP TO THE GRADE OF THE STREET.
- IN NO CASE SHALL THE WIDTH OF THE SIDEWALK ACCESS RAMP BE LESS THAN 4'.
- USE CLASS A (3000 PSI) CONCRETE WITH A SMOOTH FINISH IN ORDER TO OBTAIN A RICH, NON-SKID SURFACE.
- A 1/2" EXPANSION JOINT INSTALLED FULL DEPTH WILL BE REQUIRED WHERE THE CONCRETE SIDEWALK ACCESS RAMP JOINS THE CURB AND ALSO WHERE NEW CONCRETE ADJUTS EXISTING CONCRETE.
- CURB RAMPS SHOULD BE PLACED PARALLEL TO THE DIRECTION OF TRAVEL.

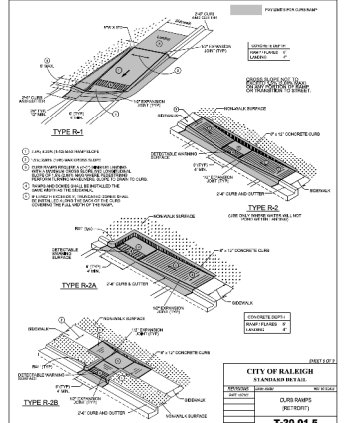
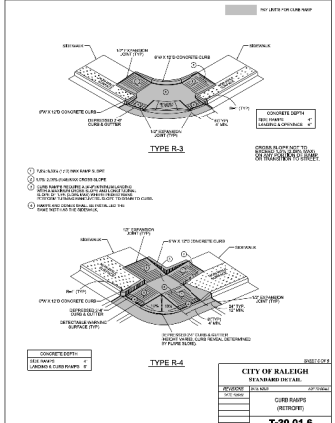
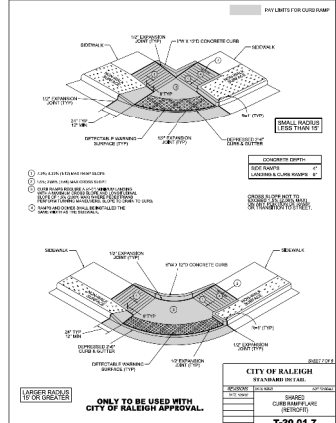

4/8/2024  
 City of Durham Group, K. Deaton, J. D.

## PEDESTRIAN SAFETY RAIL

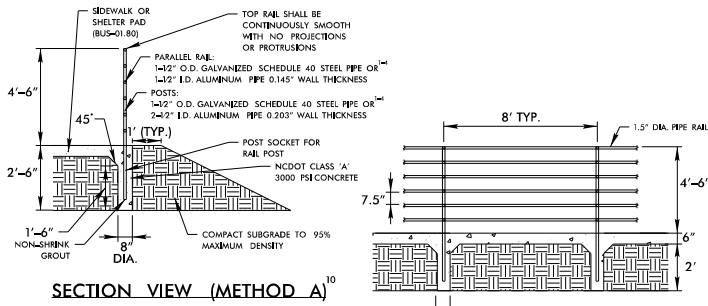

SECTION VIEW (METHOD A)<sup>10</sup>

HORIZONTAL VIEW (METHOD A)

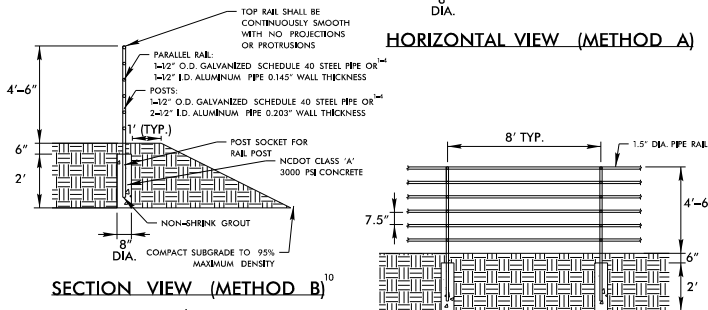

SECTION VIEW (METHOD B)<sup>10</sup>

HORIZONTAL VIEW (METHOD B)

ALUMINUM POST MOUNT (METHOD C)<sup>10</sup>

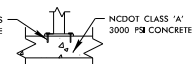

- NOTES:
- CONSTRUCT PROPOSED STEEL PIPE RAIL OF 1.5" DIAMETER SCHEDULE 40 PLAIN END GALVANIZED STEEL PIPE MEETING REQUIREMENTS OF ASTM A53.
  - REPAIR GALVANIZING IN ACCORDANCE WITH SECTION 1076 OF THE NCDOT STANDARD SPECIFICATIONS.
  - PAINT, IF REQUIRED BY ENGINEER IN ACCORDANCE WITH SECTION 1080 OF THE NCDOT STANDARD SPECIFICATIONS.
  - WELD IN ACCORDANCE WITH ARTICLE 1072-18 OF THE NCDOT STANDARD SPECIFICATIONS.
  - GOTRANGLE WILL BE REQUIRED TO PERFORM A SAFETY AND SECURITY REVIEW FOR ALL BUS STOP LOCATIONS. CONTACT GOTRANGLE'S PLANNING & CAPITAL DEVELOPMENT STAFF AT 919-447-4444 TO SCHEDULE A REVIEW.
  - SHOP DRAWINGS OF PEDESTRIAN SAFETY RAIL ARE TO BE PROVIDED TO GOTRANGLE FOR REVIEW PRIOR TO APPROVAL.
  - EARTH SLOPES STEEPER THAN 2:1 ADJACENT TO TRANSIT PASSENGER AREAS ARE NOT RECOMMENDED AND WOULD REQUIRE SUPPORTING CALCULATIONS AND APPROVAL BY GOTRANGLE.
  - EXCEPTIONS TO THE REQUIREMENTS STATED MAY BE CONSIDERED ON A CASE-BY-CASE BASIS WITH DOCUMENTATION BY THE ENGINEER AND APPROVAL BY GOTRANGLE.
  - PREFERRED METHOD OF INSTALLATION IS TO BE DETERMINED BY GOTRANGLE.

## PEDESTRIAN HANDRAIL

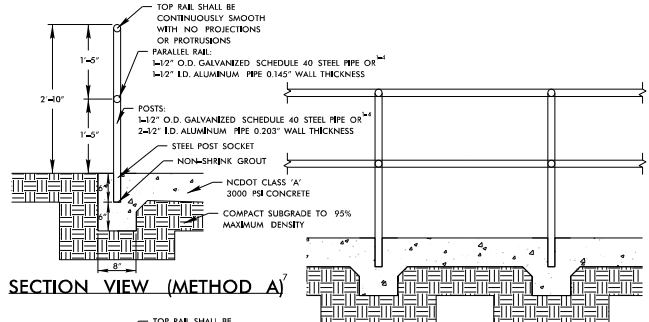

SECTION VIEW (METHOD A)<sup>7</sup>

HORIZONTAL VIEW (METHOD A)

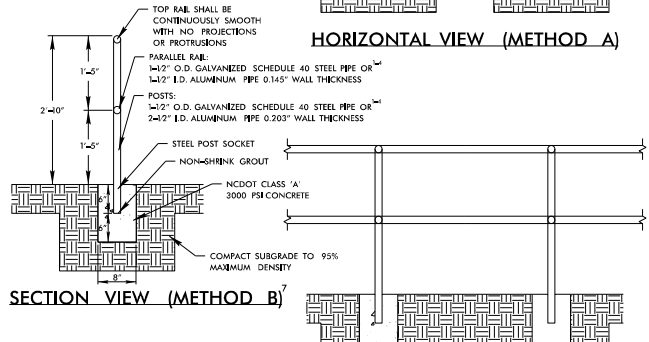

SECTION VIEW (METHOD B)<sup>7</sup>

HORIZONTAL VIEW (METHOD B)

ALUMINUM POST MOUNT (METHOD C)<sup>7</sup>



- NOTES:
- CONSTRUCT PROPOSED STEEL PIPE RAIL OF 1.5" DIAMETER SCHEDULE 40 PLAIN END GALVANIZED STEEL PIPE MEETING REQUIREMENTS OF ASTM A53.
  - REPAIR GALVANIZING IN ACCORDANCE WITH SECTION 1076 OF THE NCDOT STANDARD SPECIFICATIONS.
  - PAINT, IF REQUIRED BY ENGINEER IN ACCORDANCE WITH SECTION 1080 OF THE NCDOT STANDARD SPECIFICATIONS.
  - WELD IN ACCORDANCE WITH ARTICLE 1072-18 OF THE NCDOT STANDARD SPECIFICATIONS.
  - SHOP DRAWINGS OF PEDESTRIAN SAFETY RAIL ARE TO BE PROVIDED TO GOTRANGLE FOR REVIEW PRIOR TO APPROVAL.
  - PLACEMENT OF HANDRAIL IN RELATION TO SHOULDER BREAK POINT AND SIDEWALK MAY BE MODIFIED AS DIRECTED BY THE ENGINEER.
  - PREFERRED METHOD OF INSTALLATION IS TO BE DETERMINED BY GOTRANGLE.

SHEET #  
2E-1



CITY OF DURHAM  
GODURHAM BUS STOPS  
DETAILS

REVISIONS	DATE	DESCRIPTION

DRAWN BY: EHA  
CHECKED BY: BRL

NOT TO SCALE



4/8/2024  
 City of Durham, North Carolina  
 Group: K. Deaton, EHA



CITY OF DURHAM  
GODURHAM BUS STOPS  
DETAILS

REVISIONS	DATE	DESCRIPTION

DATE: 04/08/2024  
CREATED BY: EHA  
CHECKED BY: BKL

NOT TO SCALE



**DRMP**  
DRMP CONSULTANTS  
5000 FAIRVIEW PLACE  
RALEIGH, NC 27609  
(919) 875-5113  
NC LICENSE NO. 14-124  
www.drmp.com

DOCUMENT NOT CONSIDERED FINAL UNLESS ALL SIGNATURES COMPLETED

**STEEL BOLLARD**

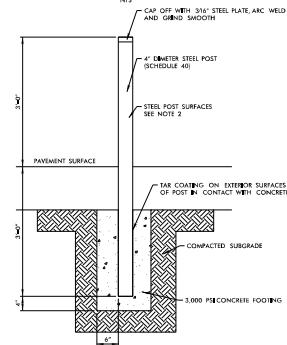

- NOTES
1. ENSURE 1' CLEAR SPACE BETWEEN EDGE OF BOLLARD AND ANY PROPOSED ANCHORS.
  2. ALL SURFACES ARE TO BE HOT DIPPED GALVANIZED AND SHOP PRIME AND PAINTED WITH TWO COATS INDUSTRIAL ENAMEL SAFETY YELLOW.

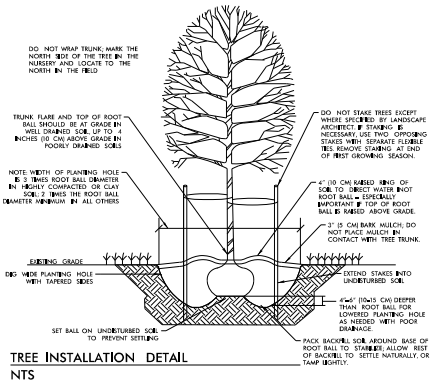

**TREE INSTALLATION DETAIL**  
NTS

- DO NOT STAKE TREES EXCEPT WHERE SPECIFIED BY LANDSCAPE ARCHITECTS. IF STAKING IS NECESSARY USE TWO OPPOSING STAKES WITH STAPLES. REMOVE STAKES AT END OF FIRST GROWING SEASON.
- DO NOT STAKE TREES EXCEPT WHERE SPECIFIED BY LANDSCAPE ARCHITECTS. IF STAKING IS NECESSARY USE TWO OPPOSING STAKES WITH STAPLES. REMOVE STAKES AT END OF FIRST GROWING SEASON.
- IF PLANTING HOLES ARE DUG WITH A LARGE AUGER BRUSHING DOWN THE SIDES WITH A SHOVEL CAN ELIMINATE GLAZING AND CREATE THE PREPARED SOILING BED.
- AVOID PURCHASING TREES WITH TWO LEADERS OR REMOVE ONE AT PLANTING. OTHERWISE DO NOT PRUNE TREE AT PLANTING. EXCEPT FOR PRUNING STRUCTURAL CORRECTIONS.
- BEFORE PLANTING ADD 3" OF TWO ONE OF WELL COMPOSTED LEAVES, RECYCLED YARD WASTE OR OTHER COMPOST AND BELAY TOP 1" TO ONE OF PREPARED SOIL. ADD COMPOST AT 100% BY VOLUME TO SOILING.
- DO NOT WHIP TRUNK. MARK THE NORTH END OF THE TREE IN THE HUBBY AND LOCATE TO THE NORTH IN THE FIELD.
- TRUNK FLARE AND TOP OF ROOT BALL SHOULD BE AT GRADE BY WELL DRAINED SOIL UP TO 4 INCHES OR ON AN OVER GRADE BY POORLY DRAINED SOILS.
- NOTE: NORTH OR PLANTING HOLE IS 3 TIMES ROOT BALL DIAMETER IN HIGHLY COMPACTED OR CLAY SOIL. 2 TIMES THE ROOT BALL DIAMETER THROUGHOUT BY ALL OTHERS.
- 4" TO ONE INCH RING OF SOIL TO LIMIT WATER ROOT ROOT BALL. ESPECIALLY IMPORTANT IF TOP OF ROOT BALL IS RAISED ABOVE GRADE.
- 2" IS ONE INCH MULCH. DO NOT PLACE MULCH IN CONTACT WITH TREE TRUNK.
- EXTEND STAKES INTO UNDISTURBED SOIL.
- 4x4" STAKES OR OTHERS THIN ROOT BALL FOR LOWERED PLANTING HOLE AS NEEDED WITH POOR DRAINAGE.
- PACK BACKFILL SOIL AROUND BASE OF ROOT BALL TO STABILIZE. ALLOW REST OF BACKFILL TO SETTLE NATURALLY OR TAMP GENTLY.
- SET BALL ON UNDISTURBED SOIL TO PREVENT SETTLING.





**EXISTING SURVEY/DEMOLITION PLAN**

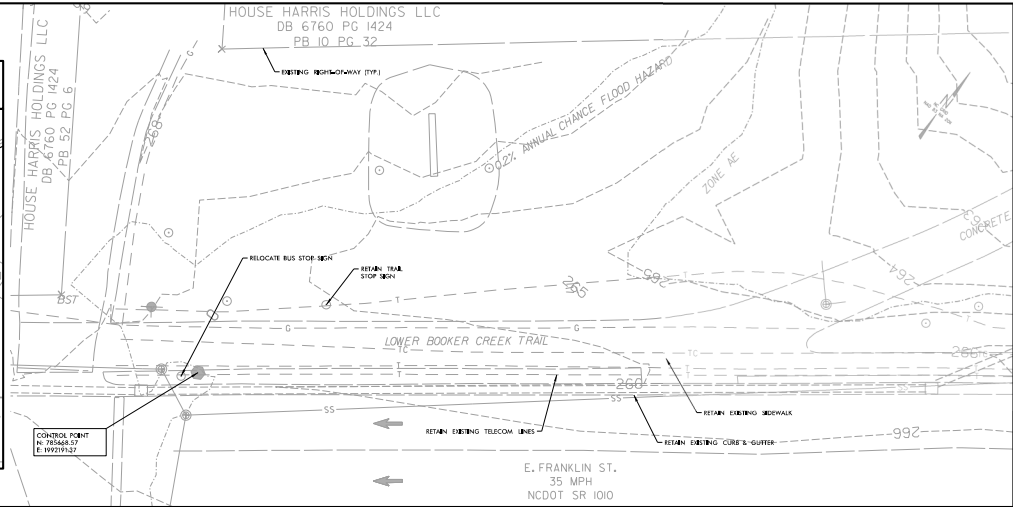
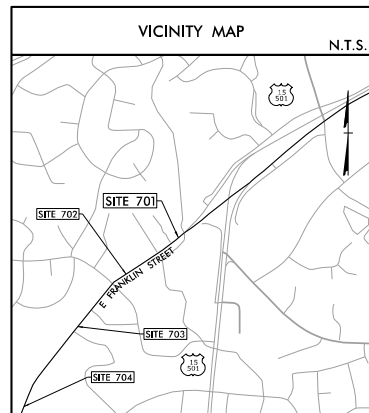

**SITE NO. 701**

GO **Triangle**

**CITY OF DURHAM**

**GODURHAM BUS STOPS**

**E. FRANKLIN STREET (WB)**

**AT BOOKER CREEK GREENWAY**

REVISIONS	DATE	DESCRIPTION

DATE: 04/08/2024  
 DESIGNED BY: EHA  
 CHECKED BY: BRL

0 5' 10'

**DRMP**  
 5800 FARMWOOD PLACE  
 RALEIGH, NC 27617  
 (919) 872-5113  
 WWW.DRMP.COM

DOCUMENT NOT CONSIDERED FINAL UNLESS ALL SIGNATURES COMPLETED

**PROPOSED PLAN**

- NOTES:
- SEE GENERAL NOTES, LIST OF STANDARDS, & DETAILS ON SERIES 2 SHEETS.
  - NO RIGHT-OF-WAY OR EASEMENTS HAVE BEEN ACQUIRED ON ADJACENT PROPERTIES. COMPLETE ALL WORK WITHIN EXISTING RIGHT-OF-WAY.
  - MOUNT SIGN 84" ABOVE SIDEWALK. 2' MIN. & 8' MAX. CLEAR FROM EDGE OF PAVEMENT TO EDGE OF SIGN.
  - BUS STOP SECURITY LIGHTING SYSTEM ACTIVATION BUTTON IS TO FACE SOUTH TOWARD THE EXISTING TRAIL. PUSH BUTTON TO BE MAXIMUM 10" FROM EDGE OF EXISTING TRAIL.

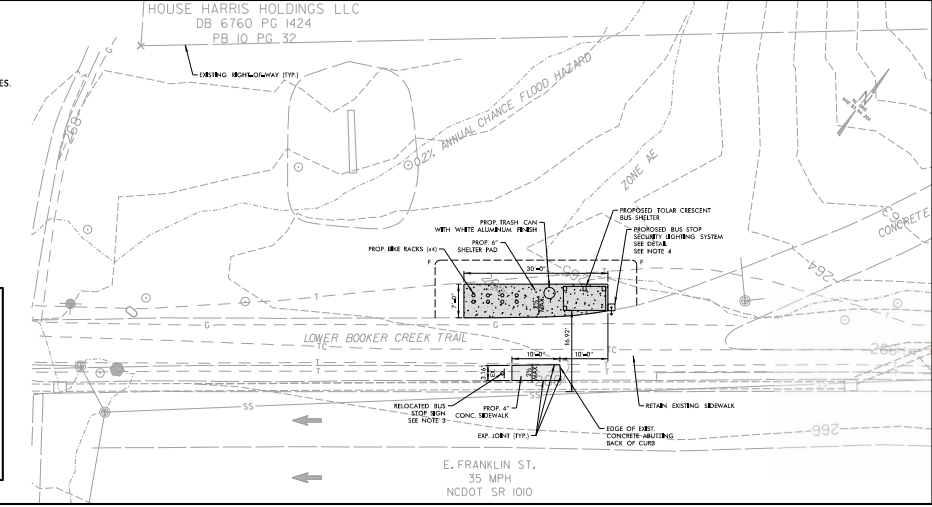
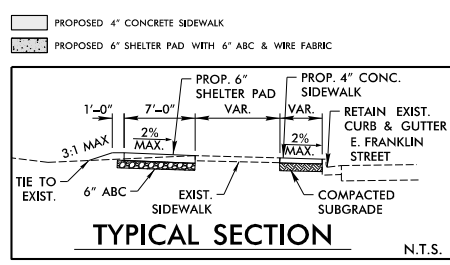

4/8/2024  
 03:17:00  
 35%  
 701\_PSH.dgn





**EXISTING SURVEY/DEMOLITION PLAN**

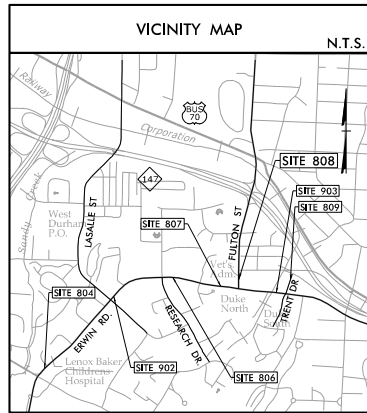

**SITE 808 DATA:**  
 PROPERTY OWNER: DUKE UNIVERSITY,  
 WILLIAMS AMY GOODREAU  
 DEVELOPMENT TIER: URBAN  
 ZONE: UC  
 REGULATORY BASIN: JORDAN LAKE  
 RIVER BASIN: CAPE FEAR  
 PIN: 0812-20-82-7066 & PUBLIC RIGHT-OF-WAY  
 SITE ACREAGE: 2.241  
 TOTAL AREA OF DISTURBANCE: 1,005 SF  
 IN ROW: 440 SF  
 TOTAL INCREASE IN IMPERVIOUS: 180 SF  
 IN ROW: 15 SF

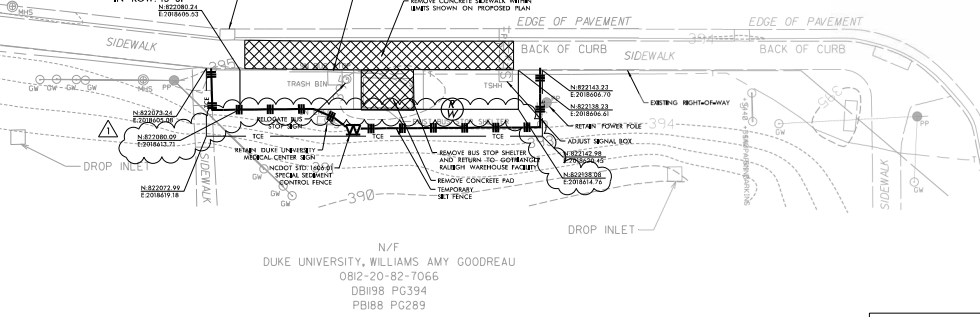

**SITE NO. 808**

GO **Durham**

**CITY OF DURHAM**  
**GODURHAM BUS STOPS**  
**FULTON STREET (NB)**  
**AT VA HOSPITAL**

10/31/2023

REVISIONS

1 UPDATE TO RIGHT OF WAY

DOCUMENT NOT CONSIDERED FINAL UNLESS ALL REVISIONS COMPLETED

DATE: 04/05/2024  
 CREATED BY: EHA  
 CHECKED BY: BHL

0 5' 10'

DRMP

3000 SILERIDGE PLACE  
 RALEIGH, NC 27617  
 (919) 875-5113  
 WWW.DRMP.COM

WATERSHED: SANDY CREEK  
 FLOODPLAIN: NOT PRESENT

**PROPOSED PLAN**

- NOTES:**
- SEE GENERAL NOTES, LIST OF STANDARDS, & DETAILS ON SERIES 2 SHEETS.
  - ALL CONCRETE SHALL BE 6" THICK FOR THIS SITE UNLESS OTHERWISE NOTED.
  - MOUNT SIGN 84" ABOVE SIDEWALK 7' MIN & 8' MAX CLEAR FROM EDGE OF PAVEMENT TO EDGE OF SIGN.
  - CONTRACTOR TO CORE 12" DIAMETER HOLE FOR SIGN PLACEMENT. FILL HOLE WITH SOIL & TOP 3" OF HOLE WITH JOINT SEALER. FOLLOW NCDOT STD. 904.50 FOR GUIDANCE.
  - PEDESTRIAN HANDRAIL IS TO BE PLACED 6" FROM THE BACK OF PROPOSED CONCRETE PAD.

- PROPOSED 6" CONCRETE SIDEWALK
- PROPOSED 6" SHELTER PAD WITH 6" ABC & WIRE FABRIC
- PROPOSED SIDEWALK AND CONCRETE PAD REMOVAL

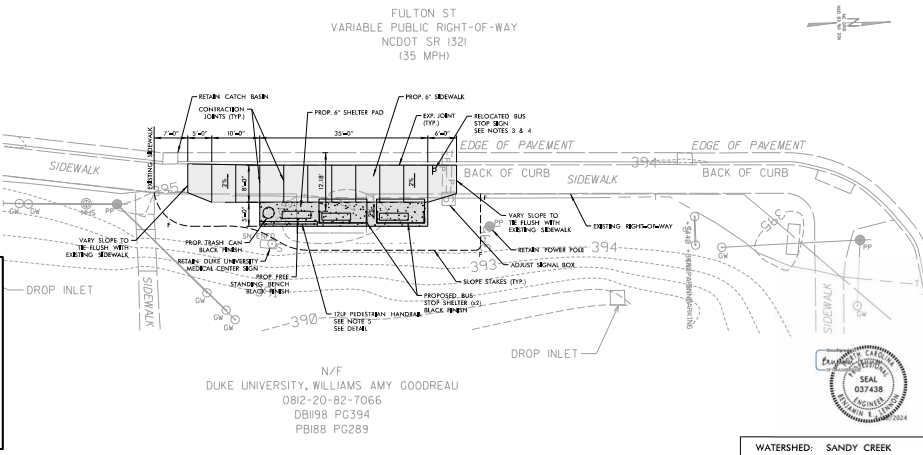
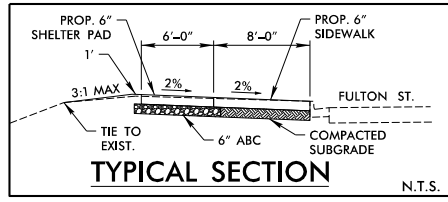

4/8/2024  
 0371401616-344  
 888-751-5113



**EXISTING SURVEY/DEMOLITION PLAN**

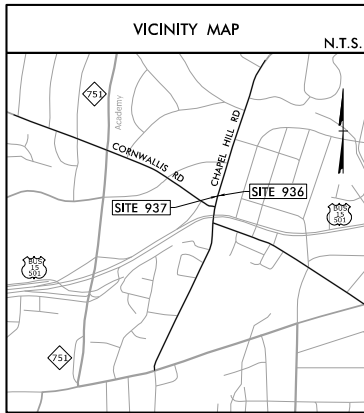

**SITE 937 DATA:**  
 PROPERTY OWNER: AKRON PROPERTIES LIMITED PARTNERSHIP  
 & PUBLIC RIGHT-OF-WAY  
 DEVELOPMENT TIER: URBAN  
 ZONE: CN  
 REGULATORY BASIN: JORDAN LAKE  
 RIVER BASIN: CAFE FEAK  
 PIN: 0811-80-60-5378 & PUBLIC RIGHT-OF-WAY  
 SITE ACREAGE: 0.281  
 TOTAL AREA OF DISTURBANCE: 255 SF  
 IN ROW: 255 SF  
 TOTAL INCREASE IN IMPERVIOUS: 97 SF  
 IN ROW: 97 SF

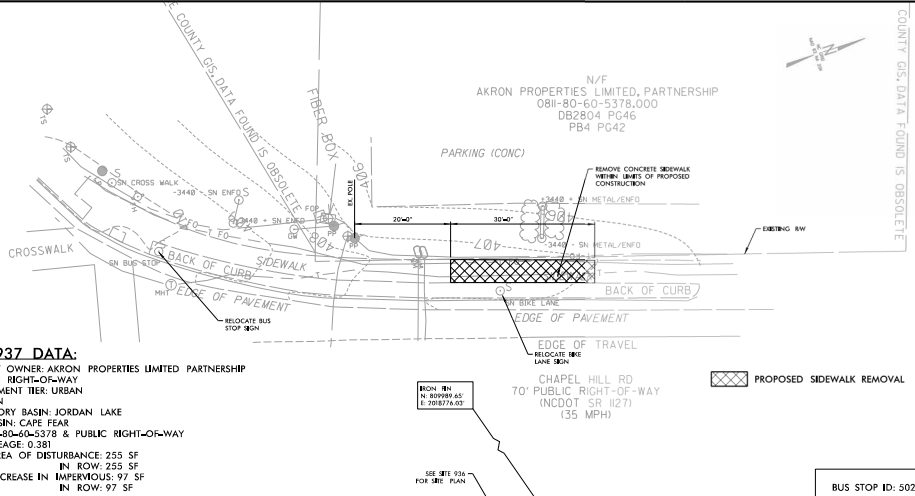

BUS STOP ID: 5021

**PROPOSED PLAN**

- NOTES:
- SEE GENERAL NOTES, LIST OF STANDARDS, & DETAILS ON SERIES 2 SHEETS.
  - NO RIGHT-OF-WAY OR EASEMENTS HAVE BEEN ACQUIRED ON ADJACENT PROPERTIES. COMPLETE ALL WORK WITHIN EXISTING RIGHT-OF-WAY.
  - ALL CONCRETE SHALL BE 6" THICK FOR THIS SITE UNLESS OTHERWISE NOTED.
  - MOUNT SIGN 84" ABOVE SIDEWALK. 2" MIN. & 8" MAX. CLEAR FROM EDGE OF PAVEMENT TO EDGE OF SIGN.
  - BUS STOP SECURITY LIGHTING SYSTEM ACTIVATION BUTTON IS TO FACE EAST TOWARD THE PROPOSED SIDEWALK. PUSH BUTTON TO BE MAXIMUM 10" FROM EDGE OF PROPOSED SIDEWALK.
  - CONTRACTOR TO INSTALL SIMM-SEAT ON EDGE OF CONCRETE PER MANUFACTURERS INSTRUCTIONS.

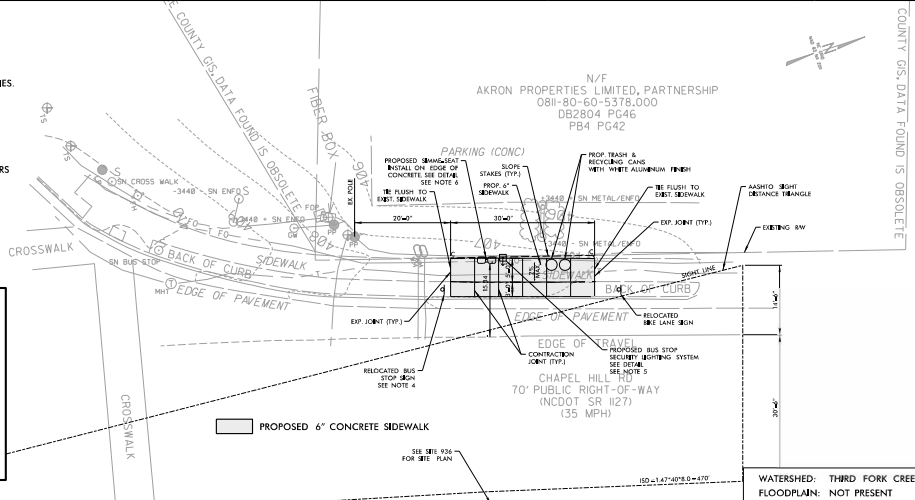
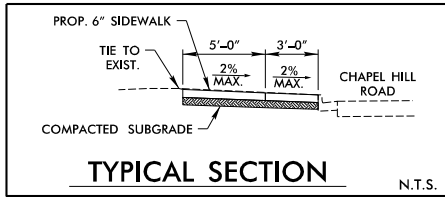

WATERSHED: THRD FORK CREEK  
 FLOODPLAIN: NOT PRESENT

SITE NO.  
**937**



CITY OF DURHAM  
 GODURHAM BUS STOPS  
 CHAPEL HILL ROAD (SB)  
 AT W. CORNWALLIS ROAD

REVISIONS	DATE	DESCRIPTION

DATE: 04/08/2024  
 DRAWN BY: EHA  
 CHECKED BY: BHL



4/8/2024  
 037438 EHA  
 937 - FSH:den



## Exhibit B

### GoTriangle Bus Amenity Improvements

04/08/2024

#### PROJECT SPECIAL PROVISIONS

##### **1. SITES REQUIRING FINAL AGREEMENTS**

The following improvement locations are in the process of being approved by adjacent property owners or appropriate jurisdictions but are included in this bid proposal. Approvals to begin work on these sites are expected to fall within the project duration with sufficient time to complete the work prior to the end of contract date. No work on these sites shall begin without written notification from the Engineer or Owner. Any work performed by the Contractor at these locations before their notice to proceed will be at no cost to the Owner and any work to repair unauthorized work will be at no additional cost to the Owner. Should this work not be feasible to complete within the project duration at the determination of the City, a contract change order may be provided or these sites may be removed from the work to be completed. Should the plans require changes, a revised plan sheet is to be provided and a change order may be issued based on changes to items and quantities to be constructed. No change order increases will be made for the inclusion of this work upon notice to proceed.

This list of sites is not intended to be all-inclusive, and it shall be the Contractor's responsibility to make sure the proper documents and authorized plans are received from the City and Engineer prior to beginning work at any location.

- **Site 804: Erwin Road at Morreene Road**

##### **2. MOBILIZATION/TRAVEL TIME**

*Mobilization/Travel Time* payment will be made by Lump Sum and is to include all mobilization of the contractor's equipment and personnel to perform the work required under this contract.

##### **3. DEMOLITION**

*Demolition* will be completed in accordance with Section 200 of the latest version of the *NCDOT Standard Specifications for Roads and Structures*. Removal of existing benches, curb and gutter, sidewalk, asphalt pavement, pipes, trimming of trees, trees and bushes within the construction limits, amenities are included in this work. Removal of additional concrete curbs, sidewalks, or other structures to the nearest joint when within two feet of joint will be considered incidental to *Demolition* and no additional payment shall be made unless otherwise noted and approved by the Engineer.

## Exhibit B

### GoTriangle Bus Amenity Improvements

04/08/2024

The hauling, transport, and delivery of amenities or other items to be returned to the Owner's facilities is considered incidental to *Demolition*.

Perform clearing on this project to the limits established by "Method of Clearing - Method II" shown on Standard No. 200.02 of the *NCDOT 2024 Roadway Standard Drawings*.

*Demolition* payment will be made by lump sum and is to include all labor, materials, transportation, and incidentals required to suitably remove and properly haul all salvaged materials or to properly dispose of as noted on the plans.

#### **4. MAILBOX, SIGN, AND MISCELLANEOUS APPURTENANCES MAINTENANCE**

The Contractor shall be required to maintain mailboxes, signs, and all miscellaneous appurtenances impacted by the construction activities in working order for the duration of construction and as directed by the Engineer. Work on the same items shall be done in a timely manner. No separate payment for work on these items will be made as the work will be considered incidental to other items in the contract unless otherwise noted in the contract documents, including final relocation of mailboxes, signs, and other miscellaneous appurtenances

#### **5. EARTHWORK**

The work covered by this section consists of the excavation, placement, and compaction or satisfactory disposal of all materials encountered within the limits of the work necessary for the construction of the project in conformity with the lines, grades, and typical sections shown on the plans or established by the Engineer.

The Contractor shall fill areas that settle unevenly during the course of construction at no additional cost to the Owner.

#### **UNCLASSIFIED EXCAVATION**

All material excavated in order to achieve the site lines, grades, and cross sections shown on the plans shall be classified as Unclassified Excavation.

Whenever encountered during work, remove any trash and non-natural debris. Remove all roots and pieces of wood or debris larger than three (3) inches in diameter.

All suitable material removed in the excavation shall be used as far as practicable in the formation of embankments, subgrades, and shoulders, and at such other places as may be indicated on the plans or directed by the Engineer. Unsuitable material and excess excavated material not required for construction of embankments shall be properly disposed of offsite at no additional cost to the Owner.

## **Exhibit B**

### **GoTriangle Bus Amenity Improvements**

**04/08/2024**

The intersection of slopes with natural ground surfaces, including the beginning and ending of cut slopes, shall be uniformly rounded as shown on the plans or as may be directed by the Engineer. Concurrent with the excavation of cuts, the Contractor shall construct intercepting berm ditches or earth berms along and on top of the cut slopes at locations shown on the plans or designated by the Engineer. All slopes shall be finished to reasonably uniform surfaces acceptable for seeding and mulching operations. All protruding roots and other objectionable vegetation shall be removed from slopes.

When the Contractor's excavation operations encounter graves, the operations shall be temporarily discontinued in the vicinity of the graves and not resumed until so directed by the Engineer.

When the Contractor's excavation operations encounter artifacts of historical or archeological significance, the operations shall be temporarily discontinued in the vicinity of the artifacts and not resumed until so directed by the Engineer. Disposition of the artifacts shall be in accordance with the requirements of the State Division of Archives and History.

A tolerance of plus or minus 0.10 foot from the established grade will be permitted in the roadbed after it has been graded to a uniform surface.

The Contractor shall be responsible during construction and until final acceptance for the maintenance of all work covered by this section.

During construction and until final acceptance, the Contractor shall shape the excavated surface to provide for the drainage of surface runoff along and throughout the length of the cut, shall construct temporary ditches, and use any other methods necessary to maintain the work covered by this section so that the work will not contribute to excessive soil erosion.

As much as practicable, the Contractor shall perform the work covered by this subsection and the construction of embankments in such a manner that cut and fill slopes will be completed to final slopes and grade in a continuous operation. The operation of removing excavation material from any cut and the placement of embankment in any fill shall be a continuous operation to completion unless otherwise permitted by the Engineer.

If grading operations are suspended for any reason whatsoever, partially completed cut and fill slopes shall be brought to the required slope and the work of seeding and mulching or other required erosion control operations shall be performed.

## **Exhibit B**

### **GoTriangle Bus Amenity Improvements**

**04/08/2024**

#### EMBANKMENT

The work covered by this subsection consists of placing in embankments, backfills, and earth berms, suitable material excavated as previously described by these specifications in conformity with the lines, grades, and typical cross sections shown on the plans or established by the Engineer. It shall include the preparation of the areas upon which the embankment is to be constructed; the formation, compaction, stability, and maintenance of the embankment.

Before embankment construction is begun, all vegetation, debris, deleterious and unsuitable material shall be removed from the area within the limits of the embankment.

Embankment material and backfill material shall consist of clean, readily compactible earthen material with a maximum particle size of two (2) inches. Embankment material shall be free from debris, organic matter, frozen or deleterious material, and shall be approved for use by the Owner.

The embankment material shall be deposited and spread in successive, uniform, approximately horizontal layers of not more than eight (8) inches in depth, loose measurement, for the full width of the cross section, and shall be kept approximately level by the use of effective spreading equipment. Each layer of the embankment shall be thoroughly compacted as hereinafter specified. Hauling shall be distributed over the full width of the embankment, and in no case will deep ruts be allowed to form during the construction of the embankment. The embankment shall be properly drained at all times.

All embankment material shall be compacted as specified herein unless otherwise provided in the contract or directed by the Engineer. Compaction equipment used by the Contractor shall be adequate to produce the required compaction and produce a uniformly constructed embankment with all layers uniformly bound to all preceding layers.

The embankment material shall be compacted to at least 95% of the maximum dry density obtained by compacting a sample of the material in accordance with ASTM D-698, except for the upper one foot of subbase below pavement base, which shall be compacted to at least 100% of the maximum dry density obtained by compacting a sample in accordance with ASTM D-698. Embankment materials shall be compacted at a moisture content satisfactory to the Engineer, which shall be approximately that required to produce the maximum dry density. The Contractor shall dry or add moisture to the embankment material when required to provide a uniformly compacted and stable embankment.



## **Exhibit B**

### **GoTriangle Bus Amenity Improvements**

**04/08/2024**

Backfill materials placed around and over pipe culverts, box culverts, and arch culverts, and embankment materials placed around other structures, shall be clean select material. The material shall be placed and compacted in a manner, which will avoid unbalanced loading and will not produce undue stress on the structure. Such embankments shall be placed in loose layers not to exceed six (6) inches in depth and each layer shall be thoroughly compacted as hereinafter specified. All pipe culverts, box culverts, and arch culverts, after being backfilled as specified in this subsection, shall be protected by a three (3) foot cover of fill at any time that heavy hauling equipment is permitted to cross during construction of the roadway. Any damage or displacement to culverts or other structures due to the Contractor's operation shall be corrected or repaired by the Contractor prior to final acceptance at no cost to the Owner.

The Contractor shall be responsible during construction and until final acceptance for the maintenance of all embankments made under the contract.

During construction and until final acceptance, the Contractor shall construct temporary or permanent earth berms along the outer edges of the top surface of the embankment, construct temporary ditches, shape the embankment surface to provide for the drainage of surface runoff along and throughout the length of the embankments, and use any other methods necessary to maintain the work covered by this section so that the work will not contribute to excessive soil erosion.

The contractor shall replace, at no cost to the Owner, any portion of embankments, which have become displaced or damaged due to carelessness or neglect on the part of the Contractor. Where the work has been properly constructed, completely drained, and properly maintained, and damage occurs due to natural causes, the Contractor will be paid at the contract unit price for the excavated material required to make necessary repairs to such damage. Measurements of quantities must be performed and approved prior to commencement of work.

All embankments shall be brought to the grade shown on the plans, or established by the Engineer, prior to final inspection and acceptance by the Engineer.

#### **UNDERCUT EXCAVATION**

The work covered by this subsection consists of the excavation, placement, and compaction and/or satisfactory disposal of materials removed from a location below the finished graded cross section.

When the Engineer determines that the natural soil materials are undesirable in their location or condition, the Engineer may require the Contractor to remove this undesirable material and backfill with approved material properly compacted.

## Exhibit B

### GoTriangle Bus Amenity Improvements

04/08/2024

Where undercutting is required adjacent to or beneath the location of a proposed drainage structure, undercut and backfill shall be done over a sufficient distance adjacent to the installation to prevent future operations from disturbing the completed drainage structure.

All materials removed in the work of undercut excavation will be classified by the Engineer as either suitable for use without excessive manipulation and utilized by the Contractor elsewhere in the work, or unsuitable for further use and disposed of by the Contractor as directed by the Engineer.

The Contractor shall conduct undercut operations in such a way that the Engineer can take the necessary measurements before any backfill is placed.

Backfill in undercut areas shall be placed as a continuous operation along with the undercutting operation. Backfill material shall not be placed in water unless otherwise permitted by the Engineer.

#### BORROW EXCAVATION

The work covered by this subsection consists of the excavation of approved material from borrow sources and the hauling and placing of this material as required on the plans or as directed by the Engineer. It shall also include the satisfactory disposal of any material from the borrow source which is not suitable for use. All work covered by this subsection shall be in accordance with Section 230 of the latest version of the *NCDOT Standard Specifications for Roads and Structures*.

#### PAYMENT

*Earthwork* payment will be made by Lump Sum and to include all labor, materials, transportation, and incidentals required to perform the work described within this section including, but not limited to, excavation, removal and disposal of undesirable material, backfilling with suitable material, constructing embankments necessary to achieve the grades indicated on the plans, and maintaining the work.

## Exhibit B

### GoTriangle Bus Amenity Improvements

04/08/2024

#### **6. EROSION CONTROL**

Temporary and permanent erosion control measures shall be furnished, constructed, maintained, and removed in accordance with the current NCDOT standard specifications with the exception of Method of Measurement and Payment. Erosion control measures shall be provided for all land disturbing activities in accordance with the Contract Documents and/or an erosion control plan approved by the North Carolina Department of Environment and Natural Resources (NCDENR). Temporary measures shall be installed by the Contractor, then inspected by the Inspector for compliance prior to any land disturbing activity. The inspection and approval process shall be required on each phase of construction. All permanent erosion control measures shall be incorporated into the work at the earliest practical time. All temporary measures shall be maintained until the permanent measures have taken effect. Temporary and permanent measures shall be coordinated to provide effective and continuous erosion control throughout the construction and post-construction period to minimize siltation of streams, lakes, reservoirs, and other impoundments, ground surfaces, and other property. These measures shall remain in effect until final approval for removal is given by the Inspector and/or the NCDENR at which time the Contractor shall remove all temporary erosion control measures at no additional cost to the Owner.

The Contractor shall be familiar with the applicable provisions of the Sedimentation Pollution Control Act of 1973, General Statutes, Chapter 113A, Article 4. The Contractor shall be responsible for incorporating conservation procedures necessary to comply with this act in minimizing erosion and sediment pollution associated with the construction of this project as directed by the Engineer.

The Contractor shall be financially responsible for any and all fines that result from the Contractor's failure to install and/or maintain erosion control measures in accordance with the Contract Documents.

The Contractor shall check all erosion and sediment control measures for stability and operation following each rainfall event, and no less than once per week. The Contractor shall make any needed repairs immediately to maintain all control measures as designed.

The Contractor shall clean out all sediment trapping devices when the device reaches 50% trap capacity and shall dispose of the sediment by spreading on the site in a protected area or by hauling away if not suitable for fill at no additional cost to the Owner.

#### **TEMPORARY MEASURES**

## Exhibit B

### GoTriangle Bus Amenity Improvements

04/08/2024

Temporary Silt Fence shall be installed around inlets, at the toe of all fill slopes, and any other necessary locations as shown on the plans and as directed by the Engineer. Silt fence shall be erected in accordance with the latest version of the *NCDOT Standard Specifications for Roads and Structures*.

Inlet Protection shall be installed around inlets and any other necessary locations as shown on the plans and as directed by the Engineer. Inlet protection shall be erected in accordance with the latest version of the *NCDOT Standard Specifications for Roads and Structures*.

Diversion Ditches shall be installed at the top of cut and fill slopes and any other necessary locations as shown on the plans and as directed by the Engineer. Diversion ditches shall be installed in accordance with the latest version of the *NCDOT Standard Specifications for Roads and Structures*.

Tree Protection Fence shall be installed around the drip line of trees in the construction work area as shown on the plans and as directed by the Engineer. The tree protection fence shall be installed in such a manner that it prevents all construction activities from encroaching into the area inside the drip line of the tree. The material and installation specifications for the tree protection fence shall be approved for use by the Engineer prior to installation.

Construction Entrances shall be installed at all points of access to the construction site. Any access point, which does not have a construction entrance, shall be barricaded to prevent its use. Construction entrances shall be installed in accordance with the latest version of the *NCDOT Standard Specifications for Roads and Structures*. Construction entrances shall be included in the unit bid price for "Mobilization."

Sediment and Filter Basins shall be installed at all points where accumulated runoff is released to natural drainage channels as shown on the plans and as directed by the Engineer. Sediment pits and filter basins shall be sized to hold 1800 cubic feet of sediment for every acre of denuded area tributary to the structure. Sediment and filter basins shall be installed in accordance with the latest version of the *NCDOT Standard Specifications for Roads and Structures*.

Catch Basin Risers/Filters shall be installed at proposed catch basin locations or at other necessary locations as shown on the plans and as directed by the Engineer. Catch basin risers/filters shall be erected in accordance with the latest version of the *NCDOT Standard Specifications for Roads and Structures*.

## Exhibit B

### GoTriangle Bus Amenity Improvements

04/08/2024

Check Dams shall be installed in ditches any and at other necessary locations as shown on the plans and as directed by the Engineer. Check dams shall be erected in accordance with the latest version of the *NCDOT Standard Specifications for Roads and Structures*.

Matting for erosion control shall be jute matting or excelsior matting. Matting for erosion control shall not be dyed, bleached, or otherwise treated in a manner that will result in toxicity to vegetation.

Jute Matting: Jute matting shall be of a uniform open plain weave of single jute yarn, forty-eight (48) inches in width, plus or minus one (1) inch. The yarn shall be of a loosely twisted construction and shall not vary in thickness by more than one-half its normal diameter. There shall be 78 warp ends, plus or minus 2, per linear yard; and the weight shall average 1.22 pounds per linear yard of the matting with a tolerance of plus or minus 5 percent.

Excelsior Matting: Excelsior matting shall consist of a machine-produced mat of curled wood excelsior at least 47 inches in width. The mat shall weigh 0.975 pounds per square yard with a tolerance of plus or minus 10 percent. At least 80% of the individual excelsior fibers shall be 6 inches or more in length. The excelsior fibers shall be evenly distributed over the entire area of the blanket. One side of the excelsior matting shall be covered with a woven fabric of twisted paper cord or cotton cord, or with an extruded plastic mesh. The mesh size for either the fabric or plastic mesh shall be a minimum of 1" x 1" and a maximum of 1-1/2" x 3".

Wire Staples: Staples shall be machine-made of No. 11 gage new steel wire formed into a "U" shape. The size when formed shall be not less than 6 inches in length with a throat of not less than 1 inch in width.

*Erosion Control* payment will be made by Lump Sum and will include all work covered by this section including, but not limited to, the labor, equipment, and materials for furnishing, installing, and removing all temporary erosion control measures indicated on the plans, and maintenance of the work throughout the life of the project as required by the Inspector.

## Exhibit B

### GoTriangle Bus Amenity Improvements

04/08/2024

#### **7. TEMPORARY TRAFFIC CONTROL**

The work covered by this section consists of the furnishing, erecting, maintaining, relocating, and removing traffic control devices in accordance with the Contract as well as the following sections from the latest version of the *NCDOT Standard Specifications for Roads and Structures*, with the exception of the method of payment, or as directed by the Engineer:

Section 1101	Work Zone Traffic Control General Requirements
Section 1105	Work Zone Traffic Control Devices
Section 1110	Work Zone Signs
Section 1115	Flashing Arrow Boards
Section 1130	Drums
Section 1135	Cones
Section 1145	Barricades
Section 1150	Flaggers

*Temporary Traffic Control* payment will be made by Lump Sum and is to include all work covered by these sections including furnishing, erecting, relocating, maintain, and removing any and/or all temporary traffic control devices.

#### **8. THERMOPLASTIC & PAINT PAVEMENT MARKINGS**

All work associated with the furnishing, installing, and removing of pavement markings shall be performed in accordance with the Contract as well as the following sections of the *NCDOT Standard Specifications for Roads and Structures* with the exception of the method of payment, or as directed by the Engineer:

Section 1205	Pavement Marking General Requirements
--------------	---------------------------------------

In the case pavement markings called for on plans are not covered by *NCDOT Standard Specifications for Roads and Structures*, the Contractor shall refer to the MUTCD and any interim approvals as applicable.

*Pavement Markings* payment will be made by Lump Sum or as otherwise indicated in the itemized proposal and is to include all work covered by these sections including furnishing, installing, and removing pavement markings.

## Exhibit B

### GoTriangle Bus Amenity Improvements

04/08/2024

#### **9. GRASS SOD/MULCH**

Sod is to be placed in all disturbed areas within the construction limits as shown on the plans.

The Contractor shall substitute mulch for sod in areas as indicated on the plans to match existing site conditions. Mulch shall be placed at a minimum of 4" thick to match the existing conditions or as called for in the plans.

Lay sod as soon as possible after it has been harvested to prevent injury. Sod should be installed within 24 hours of delivery. While installing, take action as necessary to prevent heat buildup within the unlaidd sod. Plan to unstack and unroll the sod if it cannot be laid within 48 hours. Soil should be moist (but not overly wet) before laying sod. Irrigating the soil several days before delivery is often adequate.

Start sodding from a straight edge (driveway or sidewalk) and butt strips together, staggering them in a brick-like pattern. Avoid stretching sod. Use a knife or sharp spade for trimming to fit irregularly shaped areas. Lay sod lengthwise across the face of slopes and peg or stake the pieces to prevent slippage. After the sod has been placed, roll the lawn to ensure good sod-to-soil contact.

Water sod immediately after installation. Soak sod thoroughly enough to penetrate soil below the newly installed sod to a minimum depth of two (2) inches. Contractor is responsible for insuring adequacy of water supply. The Contractor shall provide any necessary temporary means to properly water sod, including temporary pumps and sprinklers. Proper irrigation shall be required by the Contractor until the project has been inspected and is accepted by the Owner.

In some cases, sod can be laid in space planting "semi-checkerboard" fashion in order to lower costs. This method is described here assuming that the sod is cut into the standard 18 in. x 24 in. size. The first piece of sod is laid with the narrow side flush to a straight edge. This will start a row that is 24 in. wide. The next piece of sod is laid likewise but it is spaced 9 in. away and parallel to the first piece along the longer side. This is continued to make the first row. The next row is laid flush with the previous and in the same fashion except it laid offset by 9 inches, i.e. laid beginning at the centerline of the first piece of sod in the previous row. Subsequent rows are laid in this alternating pattern.

Upon completion of work, the Contractor shall remove from the site all equipment and other articles used. All excess soil, stone, and debris shall be removed and legally disposed of at no additional cost to the Owner. All work areas shall be left in a clean

## Exhibit B

### GoTriangle Bus Amenity Improvements

**04/08/2024**

and neat condition. All damage to existing construction caused by landscaping operations shall be repaired to the satisfaction of the Owner at the Contractor's expense.

The Contractor will be responsible for watering grass for a two (2) week period after installation. The Contractor shall notify Engineer once grass is installed to start the two-week period. The Contractor is to replace any dead grass at the direction of the Engineer and water for an additional two weeks at no additional cost to the Owner.

<b>LAWN SEEDING (Cool- and Warm-Season Grasses)</b>				
	<b>Typical Planting Rate/1,000 sq. ft.</b>			
<b>Lawn Grass</b>	<b>Planting Dates<sup>1</sup></b>	<b>Seeds<sup>2</sup></b>	<b>Space Planting<sup>3</sup></b>	<b>Sprigging<sup>4</sup></b>
Tall fescue	March 1 to Oct. 15 (Aug. 15 to Oct. 1 optimum)	6	-	-
Tall fescue/annual (winter) rye	Oct. 15 to March 1	6 fescue 1 rye		
Bermudagrass(seed)	Apr. 1 to Aug. 15	1 to 2	-	-
Bermudagrass (vegetative)	Apr. 15 to Aug. 30	-	5 <sup>4</sup>	5
Centipedegrass	March to July	0.25 to 0.50	5 <sup>4</sup>	-
Zoysiagrass	April to July	-	5 <sup>4</sup>	5
St. Augustinegrass	Apr. to July	-	5 <sup>4</sup>	-

#### Notes:

- <sup>1</sup> Sod consisting of cool-season grasses can be installed anytime the ground is not frozen. Sod consisting of warm- season grasses can be installed as long as soil temperature exceeds 55° F. (typically April 15 to Oct. 1)
- <sup>2</sup> Pounds of seed per 1,000 sq. ft.
- <sup>3</sup> Square yards of turf cut into 2-inch centers to plant 1,000 sq. ft.
- <sup>4</sup> Bushels of sprigs per 1,000 sq. ft. (1 sq. yd. of turf pulled apart is equivalent to 1 bushel of sprigs.)

*Grass Sod/Mulch* payment will be made at the unit price per square foot or as indicated in the itemized proposal of disturbed areas shown on the plans and as indicated on the itemized proposal including, but not limited to, all equipment, labor, materials, watering and incidentals to install and maintain the sod and mulch as directed.



## **Exhibit B**

### **GoTriangle Bus Amenity Improvements**

**04/08/2024**

Watering will be considered incidental to *Grass Sod/Mulch*. The Contractor is to replace any dead grass at the direction of the Engineer and water for an additional two weeks at no additional cost to the Owner. No direct payment will be made for areas outside of the construction limits shown on the plans that have been disturbed or damaged.

## Exhibit B

### GoTriangle Bus Amenity Improvements

04/08/2024

#### **10. ASPHALT PAVEMENT REPAIR PATCH**

Where it is necessary to open cut along or across streets with asphalt surfaces and where existing asphalt is disturbed by the removal of existing pavement or by the addition of proposed pavement, the pavement shall be replaced in accordance with City of Durham Standard Detail 408.01, or with seven (7) inches of Superpave – Asphalt Concrete Intermediate Course: Type I19.0C, and two (2) inches of Superpave – Asphalt Concrete Surface Course: Type S9.5C, or as directed by the Engineer. Use of different sections are to be at locations as identified on the plans or as directed by the engineer. The thickness of the replacement material shall be sufficient to provide a base and surface of equivalent strength to the undisturbed base and surface. The replaced pavement shall meet all applicable material and installation specifications outlined in the latest version of the *NCDOT Standard Specifications for Roads and Structures*.

*Asphalt Pavement Repair Patch* payment will be made at the unit price per ton or as otherwise indicated on the itemized proposal of asphalt material required to repair disturbed asphalt. The unit price will include all pavement repairs, both temporary and permanent, furnishing, hauling, placing, and shaping the asphalt pavement to produce a uniform, smooth driving surface. No additional payments will be issued to repair pavement damaged by the Contractor outside of the limits of existing asphalt adjacent to removal and replacement of existing pavement or adjacent to the addition of new pavement.

#### **11. MILL ASPHALT PAVEMENT, -" DEPTH**

*Mill Asphalt Pavement, -" Depth* will be constructed in accordance to Section 607 of the latest version of the *NCDOT Standard Specifications for Roads and Structures* at the specified thickness and as shown on the plans.

*Mill Asphalt Pavement, -" Depth* payment will be made at the unit price per square foot at the specified thickness or as otherwise indicated in the itemized proposal and will include the labor, hauling, materials, and all other miscellaneous items needed to mill and remove the thickness of asphalt specified and prepare the area for other construction items.

#### **12. ASPHALT PAVEMENT**

All asphalt pavement will be installed in accordance to Sections 609 & 610 of the latest version of the *NCDOT Standard Specifications for Roads and Structures* with the specified mix types and thicknesses as shown on the plans and typical sections. The pavement mixes shall meet all applicable material and installation specifications outlined

## Exhibit B

### GoTriangle Bus Amenity Improvements

**04/08/2024**

in the latest version of the *NCDOT Standard Specifications for Roads and Structures*. Contractor to provide NCDOT approved mix designs prior to paving.

*Full Depth Asphalt Pavement*, -“ will include all the mix types at the specified thicknesses for each layer to the total depth specified.

*Full Depth Asphalt Pavement*, -“ payment will be made at the unit price per square foot of the specified thicknesses and mix types installed and accepted or as otherwise indicated in the itemized proposal and will include the labor, materials, asphalt binder, and all other miscellaneous items needed to install the asphalt. See Section 610 of the latest version of the *NCDOT Standard Specifications for Roads and Structures* for full description of all items included.

*Var. Depth, (Mix Type)* will be made at the unit price per square foot of the variable depth of the specified mix type installed and accepted or as otherwise indicated in the itemized proposal and will include the labor, materials, asphalt binder, and all other miscellaneous items needed to install the asphalt. See Section 610 of the latest version of the *NCDOT Standard Specifications for Roads and Structures* for full description of all items included.

#### **13.-” CONCRETE SIDEWALK**

-” *Concrete Sidewalk* will be constructed in accordance to Section 848 of the latest version of the *NCDOT Standard Specifications for Roads and Structures* at the specified thickness and as shown on the plans with compacted subgrade.

-” *Concrete Sidewalk* payment will be made at the unit price per square foot at the specified thickness or as otherwise indicated in the itemized proposal and will include the labor, materials, compaction of subgrade, and all other miscellaneous items needed to construct the sidewalk.

#### **14.-” CONCRETE PAD**

-” *Shelter Pad* will be constructed per NCDOT Section 848 and as shown on the plans. Where called for, 6” of compacted aggregate base course is to be provided underneath the proposed pad with a minimum of 12” width of aggregate base course around the perimeter of the pad.

Where required, woven wire fabric sheets shall be placed within the shelter pad per the details provided in the plans and installed on chairs.

## Exhibit B

### GoTriangle Bus Amenity Improvements

04/08/2024

Where required, steel rebar shall be placed within the shelter pad per the details provided in the plans.

-” *Shelter Pad* payment will be made at the unit price per square foot of concrete pad installed and approved at the specified thickness or as otherwise indicated in the itemized proposal and will include the labor, materials, aggregate base course, woven wire fabric, rebar, compaction of subgrade, and all other miscellaneous items needed to construct the shelter pad.

#### **15.-” CONCRETE DRIVEWAY**

-” *Concrete Driveway* will be constructed in accordance to Section 848 of the latest version of the *NCDOT Standard Specifications for Roads and Structures* at the specified thickness and as shown on the plans with compacted subgrade.

-” *Concrete Driveway* payment will be made at the unit price per square foot at the specified thickness or as otherwise indicated in the itemized proposal and will include the labor, materials, compaction of subgrade, and all other miscellaneous items needed to construct the driveway.

#### **16.-’ –“ CURB & GUTTER**

-’ -” *Curb & Gutter* will be constructed in accordance to Section 846 of the latest version of the *NCDOT Standard Specifications for Roads and Structures*. Asphalt base course / ABC, as indicated on the plans, under the curb shall be installed per the current NCDOT standards and specifications at the thicknesses shown on the plans or as directed by the Engineer. Asphalt under the curb will extend behind the back of the proposed curb a minimum of 6” and ABC a minimum of 12”.

-’ -” *Curb & Gutter* payment will be made at the unit price per linear foot at the specified size or as otherwise indicated in the itemized proposal and will include the labor, materials, asphalt or stone base, and all other miscellaneous items needed to construct the curb & gutter. Payment for this item will not be made until complete, including backfilling, until inspected and accepted by the Owner.

#### **17.-” X -” CONCRETE CURB**

## Exhibit B

### GoTriangle Bus Amenity Improvements

04/08/2024

-" x -" *Concrete Curb* will be constructed in accordance to Section 846 of the latest version of the *NCDOT Standard Specifications for Roads and Structures*. Asphalt base course / ABC, as indicated on the plans, under the curb shall be installed per the current NCDOT standards and specifications at the thicknesses shown on the plans or as directed by the Engineer. Asphalt under the curb will extend behind the back of the proposed curb a minimum of 6" and ABC a minimum of 12".

-" x -" *Concrete Curb* payment will be made at the unit price per linear foot at the specified size or as otherwise indicated in the itemized proposal and will include the labor, materials, asphalt or stone base, and all other miscellaneous items needed to construct the curb & gutter. Payment for this item will not be made until complete, including backfilling, until inspected and accepted by the Owner.

#### **18. SURFACE MOUNTED CONCRETE CURB**

*Surface Mounted Concrete Curb* will be constructed in accordance to Section 848 of the *NCDOT Standard Specifications for Roads and Structures* and as shown on the plans on top of the proposed concrete pad or sidewalk sections. Heights of such curb may vary up to 12" measured from the top of the adjoining concrete pad or sidewalk section. Reinforcement steel "U"-bars shall be furnished and in accordance with Section 1070 of the *NCDOT Standard Specifications for Roads and Structures* and spaced as shown on the details or as directed by the Engineer.

*Surface Mounted Concrete Curb* payment will be made at the unit price per linear foot measured along the top, back of curb approved by the Engineer or as otherwise indicated in the itemized proposal and will include the labor, materials, reinforcement steel, and all other miscellaneous items needed to construct and install the curb to proposed concrete. No variance in payment will be made based on variable height of curbs shown on the plans up to 12" tall.

#### **19. BRICK PAVERS**

The Contactor is to furnish and install brick pavers as shown on the plans and in accordance with City of Durham Standard Detail Drawings 406.04, 406.05, 406.06, or other details shown on the plans as applicable. The Contractor is responsible for furnishing brick pavers that match brick in the existing vicinity unless directed otherwise by the Engineer.

The Contract is to provide a submittal of the proposed brick material for installation to the Engineer for review and approval prior to installation.

## Exhibit B

### GoTriangle Bus Amenity Improvements

**04/08/2024**

*Brick Pavers* payment will be made at the unit price per square feet of the brick pavers installed and approved or as otherwise indicated in the itemized proposal and will include the labor, materials, aggregate base course, compacting sand, galvanized stakes, furnishing brick pavers and all other miscellaneous items needed to install the brick pavers.

#### **20. RETROFIT CURB RAMP**

*Retrofit Curb Ramps* will be constructed per section 848 of the latest version of the NCDOT Standard Specifications.

*Retrofit Curb Ramp* payment will be made in accordance with Section 848-4 (see "Retrofit Existing Curb Ramps") of the latest version of the *NCDOT Standard Specifications for Roads and Structures*.

#### **21. CONCRETE CURB RAMPS**

*Concrete Curb Ramps* will be constructed in accordance to Section 848 of the latest version of the *NCDOT Standard Specifications for Roads and Structures*.

*Concrete Curb Ramps* payment will be made at the unit price per each curb ramp satisfactorily installed or as otherwise indicated in the itemized proposal and will include the labor, materials, excavation and backfilling, sawing the existing sidewalk or driveway, furnishing and placing concrete, curb and gutter, constructing and sealing joints and furnishing and installing truncated domes, and all other miscellaneous items needed to construct the curb ramp. Pay limits for ramps will be as specified on the details provided in the plans.

## Exhibit B

### GoTriangle Bus Amenity Improvements

04/08/2024

#### **22. INSTALL SHELTERS, BENCHES, AND OTHER AMENITIES**

The Owner has purchased all amenities (shelters, benches, trash cans, etc.) to be used for this project unless otherwise noted in the plans or contract documents. The Contractor will pick-up, transport, and install amenities at each site as called out on the plans. The amenities will be located on the Owner's property at the Raleigh GoTriangle warehouse at 324 W Lane Street, Raleigh. The Contractor will sign for amenities prior to leaving the Owner's storage facility indicating the condition of the amenities. The contractor will also be responsible for hauling away and disposing of any crates or pallet/packing materials off-site in a legal manner. Amenities will be assembled and installed per manufacturer's recommendations using an anchoring system. The Contractor shall provide anchor units to install amenities on concrete per manufacturer's requirements. The Contractor will coordinate all efforts with the Owner. The Contractor will be responsible for any damages to amenities once they leave the Owner's storage facility. The Contractor is to keep the storage facility clean at all times, including removing and disposing properly offsite of trash and sawdust, metal filings and other detritus created.

*Install Bus Shelter and Amenities* payment will be made at the unit price per each bus shelter to be installed or as otherwise indicated on the itemized proposal and shall include all transportation, assembly, installation and incidentals required to install the shelter, bench, and other amenities (trash cans, charging stations, etc.) as shown on the plans.

*Install Bench and Amenities* payment will be made at the unit price per each bench to be installed or as otherwise indicated on the itemized proposal and shall include all transportation, assembly, installation and incidentals required to install the bench, and other amenities (trash cans, charging stations, etc.) as shown on the plans.

*Install Simme-seat and Amenities* payment will be made at the unit price per each Simme-seat to be installed or as otherwise indicated on the itemized proposal and shall include all transportation, assembly, installation and incidentals required to install the Simme-seat and other amenities (trash cans, charging stations, etc.) as shown on the plans.

Trash cans installed at sites with no other amenity will be considered incidental to the overall contract.

## Exhibit B

### GoTriangle Bus Amenity Improvements

04/08/2024

#### **23. AMENITY ITEMS & MODELS TO BE INSTALLED**

The following table is a report of the amenities to be installed per the specifications of this contract. The model of amenities to be installed at any site is subject to change upon Owner and Engineer discretion prior to installation work by the Contractor at each location.

<b>Site #</b>	<b>Shelter Model</b>	<b>Bench Model</b>	<b>Receptacle Model</b>
<b>620</b>	16' Tolar Canopy	Tolar Bench	Tolar
<b>701</b>	9' Tolar Crescent	Tolar Bench	Tolar
<b>804</b>	Brasco Slimline (C) (Black Finish)	Brasco (Black Finish)	Dumor (Black Finish)
<b>808</b>	Brasco Slimline (C) (Black Finish) x2	Brasco (Black Finish) x3	Dumor (Black Finish)
<b>936</b>	Brasco Slimline (C) (White Aluminum)	Brasco (White Aluminum)	Brasco (White Aluminum)
<b>937</b>	-	Simme-seat (Blue)	Brasco (White Aluminum) (x2 – Trash & Recycling)
<b>956</b>	-	Brasco (White Aluminum)	Brasco (White Aluminum)



## Exhibit B

### GoTriangle Bus Amenity Improvements

04/08/2024

#### **24. INSTALL BIKE RACKS**

The Contractor is to install bike racks in accordance with the manufacturer details and as shown on the plans. The Contractor is to coordinate with the Owner to pick-up and transport bike racks from the Owner's storage location to the locations required for installation. The bike racks are to be assembled and installed per manufacturer's recommendations.

The Contractor shall provide required anchor units to install the bike rack on concrete per manufacturer's requirements. The Contractor shall coordinate the color and style of the bike racks to be installed at each location with the Owner prior to installation.

*Install Bike Racks* payment will be made at the unit price per each bike rack installed or as otherwise indicated on the itemized proposal and shall include all transportation, assembly, coordination with Owner, installation and incidentals required to install the bike racks as shown on the plans.

#### **25. INSTALL BUS STOP SECURITY LIGHTING SYSTEM**

The Contractor is to install bus stop security lighting systems in accordance with the manufacturer details and as shown on the plans. The Contractor is to coordinate with the Owner to pick-up and transport the lighting systems from the Owner's storage location to the locations required for installation. The lighting systems are to be assembled and installed per manufacturer's recommendations.

Bus stop security lighting systems are to be installed on new 12-gauge galvanized steel square tube posts, at the size indicated by the manufacturer or as directed by the Engineer or as otherwise required by the manufacturer. Lighting systems and posts shall be installed to the heights specified by the manufacturer. New sign post installations and locations with bus stop security lighting systems shall be smooth wall or "Telespar Qwik-Punch" with knockouts square tube signs, or equivalent approved by the Owner. All sign posts used shall meet the requirements of Section 1094 of the latest version of the NCDOT Standard Specification for Roads and Structures.

Installation of the lighting system will also include the installation of push buttons and wiring provided and required by the manufacturer.

## **Exhibit B**

### **GoTriangle Bus Amenity Improvements**

**04/08/2024**

*Install Bus Stop Security Lighting System* payment will be made per each lighting system satisfactorily installed and will include, but is not limited to, furnishing of the lighting system, coordination with the Owner for approval of products to be used, new square tube sign posts, installation, installation of push buttons, equipment, labor, and materials including bolts, fabrication, and machine work and any incidentals required to satisfactorily install the lighting system.

## Exhibit B

### GoTriangle Bus Amenity Improvements

04/08/2024

#### **26. PEDESTRIAN SAFETY RAIL AND HANDRAIL**

The Contractor is to furnish and install pedestrian safety rails and handrails at the size, height, locations, and of the materials specified in the plans. The pipe shall be 1.5" diameter galvanized schedule 40 steel or 1.5" aluminum pipe with 0.145" wall thickness or as otherwise approved by the Engineer. Footings for the rail are to be constructed continuously with adjacent concrete unless otherwise noted on the plans or as approved by the Engineer.

Where proposed rail is to attach to existing rails shown on the plans, the Contractor should furnish and install pedestrian safety and handrails that match the existing rails.

The Contractor is to provide a construction drawing submittal of the rails to be furnished to the Engineer for review and approval prior to installation.

Repair of galvanizing of the proposed handrail and safety rails shall be completed in accordance with Section 1076 of the latest version of the *NCDOT Standard Specifications for Roads and Structures*.

*Pedestrian Safety Rail* payment will be paid as the actual number of linear feet of safety rail installed and approved or as otherwise indicated in the itemized proposal and will include the labor, materials, fabrication, furnishing, installing, painting, concrete footings and all other miscellaneous items needed to satisfactorily install the safety rail. Measurement for *Pedestrian Safety Rail* will be made along the top of rail to the nearest whole foot.

*Pedestrian Handrail* payment will be paid as the actual number of linear feet of safety rail installed and approved or as otherwise indicated in the itemized proposal and will include the labor, materials, fabrication, furnishing, installing, painting, concrete footings and all other miscellaneous items needed to satisfactorily install the safety rail. Measurement for *Pedestrian Handrail* will be made along the top of rail to the nearest whole foot.

## Exhibit B

### GoTriangle Bus Amenity Improvements

04/08/2024

#### **27. RELOCATE SIGN**

Contractor to relocate existing signs to new 3lb galvanized steel U-channel posts or 2"x2" 12-gauge galvanized steel square tube posts, as directed by the Engineer. Sign posts also requiring a lighting system shall be of the size required by the lighting system manufacturer. Existing signs shall be stockpiled in a manner to prevent damage to sign sheeting. Contractor shall inventory these signs by street name, location, and sign message and provide inventory to Engineer prior to removal. Install all signs 7'-0" from the base of the sign to ground elevation where sign is shown on the plan sheets. Any other relocated signs are to be installed at the same height as the original condition.

Relocated bus stop signs are required to be installed on a new 12-gauge galvanized steel square tube post at the size indicated in these specifications or on the plans, 7'-0" from the base of the sign to ground elevation, 2'-0" minimum from face of curb to signpost, and ahead of stop 2'-0" from concrete section in utility strip. If an existing bus stop sign is not present or the existing sign is not salvageable, a new sign shall be obtained from the Owner.

Any backfilling, compaction, concrete, brick work, or joint sealer required to remove the existing post hole is to be considered incidental to the relocation of the sign.

*Relocate Sign* payment will be made at the unit price per each to include all equipment, labor, new sign posts, materials and incidentals to furnish and install the sign post and install existing signs as indicated here in and shown on the plan sheets. The Contractor will be responsible for all costs to replace existing signs if damaged during removal or installation.

#### **28. PERMANENT SIGNAGE**

Furnish signs with messages as shown on the plans or as directed by the Engineer and that meet the requirements of Section 901 of the latest version of the *NCDOT Standard Specifications for Roads and Structures* and the *Manual on Uniform Traffic Control Devices (MUTCD)*. Conform to the message layout, size, and color as required by the plans or as directed by the Engineer. Use prismatic retroreflective sheeting that meets the minimum retro-reflectivity values found in the latest edition of the *MUTCD*.

## Exhibit B

### GoTriangle Bus Amenity Improvements

**04/08/2024**

Permanent signage shall be installed in accordance with the latest version of the *NCDOT Standard Specifications for Roads and Structures*, *NCDOT Roadway Standard Drawings*, and the *MUTCD*. Signs provided for pedestrian and school crossings and zones shall use the strong yellow-green coloring rather than the traditional yellow of warning signs. Prismatic sheeting shall be a micro-prismatic lens reflective sheeting, classified using ASTM D4956-04. Sheeting types to be used are ASTM Type III, IV, and VI-X.

Permanent Signage shall be considered full compensation for all equipment, materials, labor, fabrication, footings, supports, hardware, and incidentals for work associated with the installation of new permanent traffic signage at locations as shown on the plans.

Contractor shall submit a sample sign type or detailed submittal for approval by the Engineer prior to ordering the sign.

Use 3lb galvanized steel U-channel sign posts or steel square tube posts, as directed by the Engineer, of sufficient length to permit the appropriate sign mounting height. New sign post installations and locations with bus stop security lighting systems shall be smooth wall or “Telespar Qwik-Punch” with knockouts square tube signs, or equivalent approved by the Owner All sign posts used shall meet the requirements of Section 1094 of the latest version of the NCDOT Standard Specification for Roads and Structures.

*Permanent Signage* payments will be made at the unit price per square foot or as otherwise indicated in the itemized proposal and will include, but is not limited to, signage fabrication and installation, including 3 lb. galvanized steel U-channel posts, square posts, bolts, fabrication, machine work and any incidentals required to install the traffic signage.

#### **29. ADJUST UTILITY BOX/VAULT**

*Adjust Utility Box/Vault* will be constructed to adjust the existing utility box/vault vertically using the appropriate materials so that it is flush with the proposed surface. The Contractor's attention is directed to Article 858-3 of the latest version of the *NCDOT Standard Specifications for Roads and Structures* for applicable construction methods.

*Adjust Utility Box/Vault* payment will be made per utility box/vault satisfactorily adjusted. Such price includes, but is not limited to, removal of a portion of the existing structure, materials, labor, equipment, coordination, and tools necessary to complete the work. Existing frames and covers are to be salvaged and reused in the adjustment. Any coordination with the owner of the utility is to be done by the contractor in accordance with this contract and is to be considered incidental to the contract.

## Exhibit B

### GoTriangle Bus Amenity Improvements

04/08/2024

#### **30. ADJUST WATER METER**

*Adjust Water Meter* will be constructed to adjust the existing water meter vertically using the appropriate materials so that it is flush with the proposed surface. The Contractor's attention is directed to Article 858-3 of the latest version of the *NCDOT Standard Specifications for Roads and Structures* for applicable construction methods.

*Adjust Water Meter* payment will be made per water meter satisfactorily adjusted. Such price includes, but is not limited to, removal of a portion of the existing structure, materials, labor, equipment, coordination, and tools necessary to complete the work. Existing frames and covers are to be salvaged and reused in the adjustment. Any coordination with the owner of the utility is to be done by the contractor in accordance with this contract and is to be considered incidental to the contract.

## Exhibit B

### GoTriangle Bus Amenity Improvements

04/08/2024

#### **31. ADJUST MANHOLE**

*Adjust Manhole* will be completed in accordance to Section 858 of the latest version of the *NCDOT Standard Specifications for Roads and Structures*.

*Adjust Manhole* payment will be made at the unit price per each manhole satisfactorily adjusted or as otherwise indicated in the itemized proposal and will include the labor, materials, and all other miscellaneous items needed to complete the adjustment.

#### **32. -" RCP, CLASS -**

*-" RCP Class* will be completed in accordance to Section 310 of the latest version of the *NCDOT Standard Specifications for Roads and Structures* at the size and class of pipe specified.

*-" RCP Class* payment will be made at the unit price per the actual number of linear feet of pipe that has been incorporated into the completed and accepted work or as otherwise indicated in the itemized proposal and will include the labor, materials, foundation conditioning materials, any required geotextile fabric, subgrade materials, any required undercut excavation, and all other miscellaneous items needed to satisfactorily install the pipe.

#### **33. FRAME WITH GRATE STD.**

*Frame with Grate Std.* will be completed in accordance to Section 840 of the latest version of the *NCDOT Standard Specifications for Roads and Structures*.

*Frame with Grate Std.* payment will be made at the unit price per each assembly incorporated into the completed and accepted work or as otherwise indicated in the itemized proposal and will include the labor, materials, grates, any hoods, covers, or grates required per the standard detail, and all other miscellaneous items needed to install the assembly.

#### **34. MASONRY DRAINAGE STRUCTURES**

*Masonry Drainage Structures* will be completed in accordance to Section 840 of the latest version of the *NCDOT Standard Specifications for Roads and Structures*.

*Masonry Drainage Structures* payment will be made at the unit price per each of the drainage structures constructed and approved or as otherwise indicated in the itemized proposal and will include the labor, materials, subgrade material, required steps and all

## **Exhibit B**

### **GoTriangle Bus Amenity Improvements**

**04/08/2024**

other miscellaneous items needed to install the structure. No additional payment will be made for structures exceeding 5' in height unless otherwise noted by the engineer.



## Exhibit B

### GoTriangle Bus Amenity Improvements

04/08/2024

#### **35. CLASS - RIPRAP**

*Class - RipRap* will be supplied and installed in accordance to Section 876 of the latest version of the *NCDOT Standard Specifications for Roads and Structures*.

*Class - RipRap* payment will be made at the unit price per ton of the class of riprap supplied, installed, and approved or as otherwise indicated in the itemized proposal and will include the labor, materials, and all other miscellaneous items needed to install the riprap.

#### **36. GEOTEXTILE FABRIC**

*Geotextile Fabric* will be supplied and installed in accordance to Section 876 of the latest version of the *NCDOT Standard Specifications for Roads and Structures* (see "Geotextile for Drainage").

*Geotextile Fabric* payment will be made at the unit price per square yard of geotextile fabric satisfactorily installed and approved or as otherwise indicated in the itemized proposal and will include the labor, materials, staples, pin, and all other miscellaneous items needed to install the geotextile fabric.

#### **37. PLANT TREE**

The height of the trees (measured from the crown of the roots to the tip of the top branch) shall not be less than the minimum size designated. Take caliber measurement six (6") inches above ground level up to and including four (4") inch caliber sizes and twelve (12") inches above the ground for larger sizes. The trunk of each tree shall be a single trunk growing from a single unmutilated crown of roots. No part of the trunk shall be conspicuously crooked as compared with normal trees of the same variety. The trunk shall be free from sunscald, frost cracks, or wounds resulting from abrasions, fire, or other causes. No pruning wounds shall be present having a diameter exceeding two inches and such wounds must show a vigorous bark on all edges. Plants shall not be pruned prior to delivery.

All woody trees and shrubs shall be balled and burlapped or grown in containers; bare-rooted trees or shrubs shall not be permitted.

For balled and burlapped trees and shrubs, burlap shall be 100% cloth burlap and must be moved with the root systems as solid units with balls of earth firmly wrapped with untreated eight (8) ounce burlap, firmly held in place by a stout cord. No poly-burlap shall be allowed on plant materials. Any use of wire cages shall be approved in writing by the Owner. Wire must not be galvanized or aluminum wire. Any balled and burlapped

## Exhibit B

### GoTriangle Bus Amenity Improvements

**04/08/2024**

trees and shrubs delivered to the site with materials other than 100% cloth burlap shall automatically be rejected and the installer shall remove them from the site within twenty-four (24) hours.

- A. The diameter and depth of the balls of earth must be sufficient to encompass the fibrous root feeding system necessary for the healthy development of the plant.
- B. No plant shall be accepted when the ball of earth surrounding its roots has been badly cracked or broken preparatory to or during the process of planting or after the burlap, staves, ropes, or platform required in connection with its transplanting have been removed.
- C. The plants and root balls shall remain intact during all operations.
- D. All plants that cannot be planted at once shall be heeled in by setting on the ground, covering the balls with soil, and watering them to maintain moisture level.

The Owner retains the right to observe trees and shrubs further for size and condition of balls and root systems, insects, injuries, and latent defects and to reject unsatisfactory or defective material at any time during progress of work. Remove rejected trees or shrubs immediately from the project site.

The Contractor shall be responsible for furnishing their own supply of water to the site at no extra cost. Any plant material injured or damaged due to the lack of water, or the use of too much water, shall be the Contractor's responsibility to correct. Water shall be free from impurities injurious to vegetation.

The Contractor shall submit a schedule for planting to the Owner for approval to ensure that the Schedule of Work will minimize the potential for plant damage and to insure timely installation of all material.

Do not prune trees and shrubs before delivery, except as approved by Owner. Protect bark, branches, and root systems from sun scald, drying, sweating, whipping, and other handling and tying damage. Do not bend or bind-tie trees or shrubs in such a manner as to destroy their natural shape. Provide protective covering of exterior plants during delivery. Do not drop exterior plants during delivery.

Planting restrictions shall be as follows:

1. Shrubs: Planting shall only occur between October 1 and April 31.

## **Exhibit B**

### **GoTriangle Bus Amenity Improvements**

**04/08/2024**

2. Non-woody plantings: Planting shall be installed during the commonly recognized planting times consistent with the specified plant species.
3. Coordinate planting periods with maintenance periods to provide required maintenance from date of Substantial Completion.
4. If overall project Substantial Completion occurs prior of the specified planting dates, planting shall not be installed until specified planting dates.

Following completion of all plant material installation, the Contractor shall request the City in writing for a formal inspection of the planting.

If a substantial number of plants are sickly or dead at the time of final inspection, acceptance will not be granted, and the Contractor's responsibility for maintenance of all plants shall be extended until replacements are made. All dead and unsatisfactory plants shall be promptly removed from the project. Replacements shall conform in all respects to the specifications for new plants and shall be planted in the same manner and location. The Contractor shall maintain replacements during the Maintenance Period.

The Contractor is to provide complete Maintenance Service by skilled employees of landscape installer. Maintain as required by these specifications. The Contractor shall follow the following Maintenance period provisions:

1. Maintenance shall begin immediately after each plant is planted and shall continue through both Substantial Completion and the minimum twelve (12) month maintenance period as specified, herein.
2. After installation and before Substantial Completion, remove nursery stakes, tie tape, labels, wire, burlap, and other debris from plant material, plantings, and Project site. Remove tree stabilization materials at the end of the maintenance period, or as approved by Owner. Nursery tags with species name shall remain until the end of the maintenance period.
3. During the maintenance period, any decline in the condition of planted material shall require the Contractor to take immediate action to identify potential problems and undertake corrective measures.

Following planting and anytime during the Maintenance Period, plantings that die or show obvious decline or loss of more than ten (10%) percent of healthy growth, shall be removed and replaced at once unless designated otherwise in writing by the City. Replacements shall conform in all respects to the specifications for new plants and shall be planted in the same manner and location.

## Exhibit B

### GoTriangle Bus Amenity Improvements

04/08/2024

The Contractor is to warrant all installed exterior plants for the warranty period indicated against defects including death and unsatisfactory growth.

The warranty period for all plants shall be twelve (12) months from date of Substantial Completion, unless plantings are installed during their required planting date following Substantial Completion. End of Warranty period will be tied to twelve (12) months from Substantial Completion.

Plants shall be alive and in satisfactory growth at the end of the Warranty Period. Plants that die or show obvious decline or loss of healthy growth during the Warranty Period shall be removed and replaced, unless designated otherwise by the Owner. Each plant shall show at least ninety- five (95%) percent healthy growth and shall have the natural character of a plant of its species in accordance with the American Nurserymen's Association Standards. Dead or unsatisfactory plants shall be replaced only during the specified planting season.

All replacements shall be plants of the same species, variety, and size specified in the Plant Schedule and all material, installation, and incidental costs shall be borne by the Contractor, except for possible replacements due to vandalism or neglect on the part of others.

*Plant Tree* payment will be made at the unit price per each tree planted and accepted by the Owner and will include all equipment, labor, tree, materials, water, maintenance required during the warranty period, and incidentals to install and maintain the tree as directed. Watering will be considered incidental to this item. Any tree removed during demolition that was not marked for removal on the plans or by the Engineer should be replaced by a tree of the same species at no additional cost to the City.

#### **38. SURVEY CONSTRUCTION STAKES**

Survey CADD files will be provided to the Contractor at their request for use in staking the construction layout, right-of-way or easements on proposed improvements. The Contractor will be responsible for any staking and this work will be considered incidental to the contract.

#### **39. MATERIALS SAMPLING & TESTING**

The Contractor is responsible for the quality control of his/her work including but not limited to compaction of subgrade, compaction of aggregate base course, strength of concrete, etc. The Owner may use an independent testing laboratory to test areas found

## **Exhibit B**

### **GoTriangle Bus Amenity Improvements**

**04/08/2024**

to be noncompliant. The Contractor will be responsible for all repair and replacement costs including retesting costs for areas found to be noncompliant.

## Exhibit B

### GoTriangle Bus Amenity Improvements

04/08/2024

#### **40. CLEARING AND GRUBBING**

The Contractor shall furnish all labor, equipment, materials, tools, etc. and shall perform all clearing and grubbing of trees, down timber, logs, snags, brush undergrowth, heavy growth of grass or weeds, debris, and rubbish, etc. All such material shall be disposed of by burning (when permitted), suitable removal from the site, or other means acceptable to the Engineer.

The width of clearing for the project shall be limited to the right of way and/or temporary and permanent easements as noted on the drawings. The entire width of the permanent easement is to be cleared unless otherwise indicated by clearing limits noted on the drawings. Clearing and grubbing shall be conducted in a manner to prevent damage to vegetation that is intended to remain growing and also to prevent damage to adjacent property.

The Engineer will designate all areas of growth or individual trees inside the clearing limits, which are to be preserved due to their desirability. The trees to be preserved will be shown in the Contract Documents or designated by the Engineer.

All spoil materials that are removed by clearing and grubbing operations shall be adequately disposed of, removed from the site or burned if permitted by the appropriate authorities. The contractor shall be responsible for controlling fires in compliance with all Federal, State or local laws.

All work performed under this section shall cause a minimum of erosion and sediment pollution as outlined in this contract. Installation of temporary or permanent erosion control measures shall occur immediately after clearing and grubbing operations have begun or as directed by the Engineer.

No direct payment will be made for this work, as the cost of this work is being paid for at the contract lump sum price for *Demolition*.

## Exhibit B

### GoTriangle Bus Amenity Improvements

04/08/2024

#### **41. SHOULDER AND FILL SLOPE MATERIAL (LUMP SUM EARTHWORK)**

Perform the required shoulder and slope construction for this project in accordance with the applicable requirements of Section 226 of the Standard Specifications except as follows:

- Construct the top 6 inches of shoulder and fill slopes with soils capable of supporting vegetation.
- Provide soil with a P.I. greater than 6 and less than 25 and with a pH ranging from 5.5 to 6.8. Remove stones and other foreign material 2 inches or larger in diameter. All soil is subject to test and acceptance or rejection by the Engineer.
- Obtain material from approved borrow site. The Contractor is responsible for any erosion control requirements of off-site borrow sites.

No direct payment will be made for this work, as the cost of this work will be considered to be covered under the contract lump sum price for *Earthwork*.

#### **42. BURNING RESTRICTIONS**

Open burning is not permitted on any portion of the limits established for this project. Do not burn the clearing, grubbing or demolition debris designated for disposal and generated from the project at locations within the project limits, off the project limits or at any waste or borrow sites in this county. Dispose of the clearing, grubbing and demolition debris by means other than burning, according to state or local rules and regulations.

## **Exhibit B**

### **GoTriangle Bus Amenity Improvements**

**04/08/2024**

#### **43. COORDINATION WITH UTILITY COMPANIES**

Utilities as shown on the plans are intended to represent general locations only. It shall be the responsibility of the Contractor, prior to construction, to contact appropriate utility owners and precisely locate utilities that could be affected by the proposed construction. If the utility belongs to the Owner, the Contractor shall dig sample holes to uncover the utility. The digging of sample holes shall be coordinated with the Engineer who will determine the number of such holes and will schedule the Owner to locate utility vertical and horizontal locations. There is no line item to pay for digging work. Work is considered incidental to other pay items.

The Contractor shall be responsible for repair of any damage to the utility as well as any other damage may be caused due to the disturbance of the Utility. The Contractor will not be permitted to submit any claims for delays caused by utility relocation and proposed utility construction.

The Contractor shall be responsible for coordinating concurrent construction directly with utility owner representatives. Coordination efforts and concurrent construction conflicts will be addressed and discussed during the pre-construction meeting. The Owner, at the time of pre-construction conference, will provide names, addresses and telephone numbers of private utility owner representatives.

All underground utilities may not have been identified. The Contractor shall call North Carolina One Call to identify underground utilities before starting any digging and/or excavation operation.

The Contractor shall be responsible for field verifying heights and locations of power lines and will be required to maintain the distance from the power lines in accordance with local, State and Federal Safety regulations.



**Exhibit B**

**GoTriangle Bus Amenity Improvements**

**04/08/2024**

**44. NCDOT ERRATA**

Revise the *NCDOT 2024 Standard Specifications* as follows:

END OF SECTION